

Conceptual and Visual Understanding of Hydraulic Head and Groundwater Flow

Andrew J.B. Cohen and John A. Cherry

Conceptual and Visual Understanding of Hydraulic Head and Groundwater Flow

The Groundwater Project

i

Andrew J.B. Cohen

*New Jersey Institute of Technology
Newark, New Jersey, USA*

John A. Cherry

*G360 Institute for Groundwater Research
Guelph, Ontario, Canada*

*Conceptual and Visual
Understanding of Hydraulic Head and
Groundwater Flow*

*The Groundwater Project
Guelph, Ontario, Canada*

SUSTAINABLE INNOVATIVE RESOURCES MANAGEMENT

Smart solutions for using resources efficiently,
protecting our planet, and securing
a prosperous future.



SECTORS



WATER



ENVIRONMENT



MINING
INTEGRATED WATER SERVICES
LIFECYCLE



GREEN ENERGY



DIGITIZATION
AND AUTOMATION



COMPREHENSIVE
MONITORING SOLUTIONS



DISASTER MANAGEMENT
SYSTEMS CATEGORY

SERVICES



The Groundwater Project relies on private funding for book production and management of the Project.

Please consider sponsoring the Groundwater Project so that our books will continue to be freely available. <https://gw-project.org/donate/>

Thank you.

All rights reserved. This publication is protected by copyright. No part of this book may be reproduced in any form or by any means without permission in writing from the authors (to request permission contact: permissions@gw-project.org). Commercial distribution and reproduction are strictly prohibited.

Groundwater-Project (GW-Project) works are copyrighted and can be downloaded for free from gw-project.org. Anyone may use and share gw-project.org links to download GW-Project's work. It is neither permissible to make GW-Project documents available on other websites nor to send copies of the documents directly to others. Kindly honor this source of free knowledge that benefits you and all those who want to learn about groundwater.

Copyright © 2020 Andrew J.B. Cohen and John A. Cherry (The Authors)

Published by the Groundwater Project, Guelph, Ontario, Canada, 2020.

Cohen, Andrew J.B.

Conceptual and Visual Understanding of Hydraulic Head and Groundwater Flow
/ Andrew J.B. Cohen and John A. Cherry - Guelph, Ontario, Canada, 2020.

58 pages

ISBN: 978-1-7770541-6-8

DOI: <https://doi.org/10.21083/978-1-7770541-6-8>

Please consider signing up for the GW-Project mailing list to stay informed about new book releases, events, and ways to participate in the GW-Project. When you sign up for our email list, it helps us build a global groundwater community. [Sign up](#).

APA (7th ed.) Citation

Cohen, A.J.B and Cherry, J.A. (2020). *Conceptual and Visual Understanding of Hydraulic Head and Groundwater Flow*. The Groundwater Project. <https://doi.org/10.21083/978-1-7770541-6-8>.



Domain Editors: John Cherry and Eileen Poeter

Board: John Cherry, Paul Hsieh, Ineke Kalwij, Stephen Moran, Everton de Oliveira and Eileen Poeter

Steering Committee: John Cherry, Ying Fan, Allan Freeze, Paul Hsieh, Ineke Kalwij, Douglas Mackay, Stephen Moran, Everton de Oliveira, Beth Parker, Eileen Poeter, Warren Wood, and Yan Zheng.

Cover Image: Cohen and Cherry, 2020

Dedication

Dedicated to the generous sharing of groundwater knowledge.

The Groundwater Project Foreword

The United Nations Water Members and Partners establish their annual theme a few years in advance. The theme for World Water Day of March 22, 2022, is “Groundwater: making the invisible visible.” This is most appropriate for the debut of the first Groundwater Project (GW-Project) books in 2020, which have the goal of making groundwater visible.

The GW-Project, a non-profit organization registered in Canada in 2019, is committed to contribute to advancement in education and brings a new approach to the creation and dissemination of knowledge for understanding and problem solving. The GW-Project operates the website <https://gw-project.org> as a global platform for the democratization of groundwater knowledge and is founded on the principle that:

“Knowledge should be free and the best knowledge should be free knowledge.” Anonymous

The mission of the GW-Project is to provide accessible, engaging, high-quality, educational materials, free-of-charge online in many languages, to all who want to learn about groundwater and understand how groundwater relates to and sustains ecological systems and humanity. This is a new type of global educational endeavor in that it is based on volunteerism of professionals from different disciplines and includes academics, consultants, and retirees. The GW-Project involves many hundreds of volunteers associated with more than 200 organizations from over 14 countries and six continents, with growing participation.

The GW-Project is an on-going endeavor and will continue with hundreds of books being published online over the coming years, first in English and then in other languages, for downloading wherever the Internet is available. The GW-Project publications also include supporting materials such as videos, lectures, laboratory demonstrations, and learning tools in addition to providing, or linking to, public domain software for various groundwater applications supporting the educational process.

The GW-Project is a living entity, so subsequent editions of the books will be published from time to time. Users are invited to propose revisions.

We thank you for being part of the GW-Project Community. We hope to hear from you about your experience with using the books and related material. We welcome ideas and volunteers!

The GW-Project Steering Committee

October 2020

Foreword

Groundwater science is complex and many types of information are needed for comprehensive understanding. However, the most basic and important information is hydraulic head (or head). Head is the elevation of the water in a well relative to a specified horizontal surface (elevation datum) such as sea level. When head is combined with basic geologic properties such as hydraulic conductivity within the context of Darcy's law, much can be inferred about the groundwater flow direction, and this is a starting point for investigating all types of groundwater situations. To measure head, we drill or dig a hole to the water table or, for deep groundwater systems drill a deep hole, and seal a pipe in the hole, so that water flows from the bottom portion of the pipe that is open to the groundwater system up into the solid pipe to a stable level.

This book is aimed at the development of a conceptual understanding of hydraulic head and the associated intuitive capacity for visualizing groundwater flow in one- and two-dimensional space based on head data and information about basic geologic conditions such as hydraulic conductivity. In order to facilitate development of groundwater intuition, simple schematics are used, each representing a visualized puzzle so that after studying the sequence of puzzles and the interspersed exercises of the same form, the reader is prepared to interpret head data from groundwater systems in the field. One goal is for the reader to be able to sketch diagrams as answers to many forms of "puzzles" relating head and hydraulic conductivity. This book is most effective when used in conjunction with the Groundwater-Project book [Hydrogeologic Properties of Earth Materials and Principles of Groundwater Flow](#) (Woessner and Poeter, 2020).

The senior author is a consulting hydrogeologist with broad experience and a particular interest in the design of figures to more effectively display groundwater information in multiple dimensions and who has taught contaminant hydrogeology courses at the university level.

John Cherry, The Groundwater Project Leader
Guelph, Ontario, Canada, October 2020

Preface

The motivation for developing this book stems from the authors' experience teaching hydrogeology. Specifically, we have found that the most fundamental underpinnings of groundwater science, namely hydraulic head and Darcy's law, although simple in mathematical form, are often challenging for students to conceptualize and visualize, which are essential skills needed to interpret hydrogeologic data. Recognizing the power of visual learning, we present numerous sketches that relate hydraulic head and geologic properties for various porous media flow scenarios. After studying the sequence of figures and interspersed exercises, the reader is prepared to interpret head data that are collected from groundwater systems in field settings. The exercises require contemplation and integration of concepts, not solving equations.

Acknowledgements

We thank the following individuals for their thorough and useful reviews of this book:

- ❖ Peter Gray, Vice President and Senior Hydrogeologist, MTE Consulting, Canada;
- ❖ Jana Levison, Associate Professor, G360 Institute for Groundwater Research, School of Engineering, University of Guelph;
- ❖ Eelco Lucas, Director, Institute for Groundwater Studies (IGS), University of the Free State, South Africa;
- ❖ Jessica Meyer, Assistant Professor, Department of Earth and Environmental Sciences, University of Iowa;
- ❖ Guy Patrick, Director, Patrick Consulting Incorporated, British Columbia, Canada;
- ❖ Elisha Persaud, PhD candidate in Water Resources Engineering, University of Guelph;
- ❖ Kamini Singha, Professor, Department of Geology and Geological Engineering, Colorado School of Mines;
- ❖ Hugh Whiteley, Adjunct Professor, Engineering, University of Guelph, Canada; and,
- ❖ William Woessner, Emeritus Regents' Professor of Hydrogeology, University of Montana, Missoula, Montana, USA.

We are grateful for Amanda Sills' oversight of this book and to Elhana Dyck for copyediting, both of the Groundwater Project, Guelph, Ontario, Canada. We appreciate Eileen Poeter's (a Groundwater Project volunteer from Colorado School of Mines in Golden, Colorado, USA) copyediting, layout editing and production of this book.

Table of Contents

DEDICATION	v
THE GROUNDWATER PROJECT FOREWORD	vi
FOREWORD	vii
PREFACE	viii
ACKNOWLEDGEMENTS	ix
TABLE OF CONTENTS	x
1 NATURE AND PURPOSE OF THIS BOOK	1
2 FUNDAMENTAL CONSIDERATIONS	2
2.1 Darcy's Law	2
2.2 HYDRAULIC HEAD GRADIENT AS A MANIFESTATION OF OTHER VARIABLES AND CONDITIONS	6
<i>Example Problem 1</i>	8
2.3 COMPONENTS OF HYDRAULIC HEAD	8
<i>Example Problem 2</i>	12
3 DARCIAN HEAD PROFILES	13
4 EQUIPOTENTIAL LINES AND FLOW DIRECTION	19
4.1 GENERAL CONSIDERATIONS	19
<i>Example Problem 3</i>	21
5 SATURATED STEADY FLOW AT THE FIELD SCALE	23
5.1 HYDRAULICS OF FLOW IN CONFINED AQUIFERS	24
<i>Example Problem 4</i>	25
5.2 HYDRAULICS OF FLOW IN UNCONFINED AQUIFERS	26
<i>Example Problem 5</i>	28
<i>Example Problem 6</i>	32
<i>Example Problem 7</i>	32
<i>Example Problem 8</i>	33
<i>Example Problem 9</i>	33
5.3 AQUIFERS AND AQUITARDS	34
<i>Example Problem 10</i>	37
<i>Example Problem 11</i>	38
<i>Example Problem 12</i>	39
6 SUMMARY	40
7 SOLUTIONS TO EXAMPLE PROBLEMS	41
PROBLEM 1 SOLUTION	41
PROBLEM 2 SOLUTION	42
PROBLEM 3 SOLUTION	43
PROBLEM 4 SOLUTION	44
PROBLEM 5 SOLUTION	45
PROBLEM 6 SOLUTION	46
PROBLEM 7 SOLUTION	48
PROBLEM 8 SOLUTION	49
PROBLEM 9 SOLUTION	50
PROBLEM 10 SOLUTION	51
PROBLEM 11 SOLUTION	52

PROBLEM 12 SOLUTION	54
8 REFERENCES	56
9 ABOUT THE AUTHORS	57

1 Nature and Purpose of this Book

This book introduces the most basic and essential concepts in groundwater science. In particular, the fundamentals of Darcy's law, hydraulic head, hydraulic gradient, and potentiometric contours are presented in a manner with minimal mathematic detail but rather in a conceptual and visual manner that transforms intuition into knowledge. This book pairs well with the work by Woessner and Poeter (2020), which presents the fundamentals with mathematical underpinnings. The book introduces the Darcy experiment and Darcy's law in the context of hydraulic head gradients to establish head as the key parameter along with hydraulic conductivity for understanding flow. Conceptually, it shows that water wells are piezometers used to measure hydraulic head. Emphasis is on steady, saturated flow, first in one dimension and then in two dimensions to show how head distributions and gradients within the saturated zone of the subsurface are influenced by variability of hydraulic conductivity and the boundaries of the flow domain. An emphasis is placed on illustrating how head profiles (vertical head distribution) and potentiometric contours are used to infer groundwater flow directions in aquifers where flow is generally horizontal, and in aquitards where it generally is vertical. This book does not discuss flow nets in a formal way, but some figures show flow nets where the water table, equipotential lines (in map view and cross section) and flow lines are presented, because these relationships are so fundamental to groundwater science. The [Groundwater Project book](#) by Poeter and Hsieh (2020) explains flow nets and how to construct them. Overall, this book will provide students with the foundation needed to visualize groundwater flow patterns based on water elevation measured in wells and with consideration of basic geologic properties.

Since hydraulic head measurements can be obtained in the field relatively easily with minimal uncertainty, understanding the spatial nature of head data is key to the development of hydrogeological thinking. This book includes of a set of simple schematic figures with embedded narrative that illustrate specific points. In addition, example problems are presented throughout the book; each is a sketch figure with questions asked about what the figure shows and/or requiring sketches by the student. Answers to the questions are provided at the end of the book, along with an explanation of the rationale for the correct answer. For multiple-choice questions, the rationale for why the other choices are incorrect is presented, which provides an opportunity for deeper understanding. The example problems require contemplation and integration of concepts, not solving equations.

2 Fundamental Considerations

2.1 Darcy's Law

In 1856, Henry Darcy published results of sand column experiments he performed to better understand principles of water flow through filter beds, which were used in the design of water supply systems in Dijon, France (Darcy, 1856). As a result of the experiment, Darcy discovered a mathematical relationship relating flow to hydraulic gradient. This mathematical relationship is now referred to as Darcy's law; it is the fundamental equation describing the flow of fluid through porous media, including groundwater. He discovered that the water flow rate through a sand packed column was a linear function of the hydraulic head loss across the filter bed and not just the difference in water pressure. Besides its relevance to groundwater hydrology, Darcy's law forms the quantitative basis of many science and engineering disciplines including soil science, civil engineering, petroleum engineering, and chemical engineering. Darcy's law is fundamental to understanding and predicting the behavior of groundwater flow and is the basis for interpreting measurements such as water levels in wells.

Consider the experimental apparatus shown in **Figure 1**. Although the experimental design is not the same as Darcy's, the apparatus is analogous in that the hydraulics and mathematical relationships born by Darcy's experiment are the same.

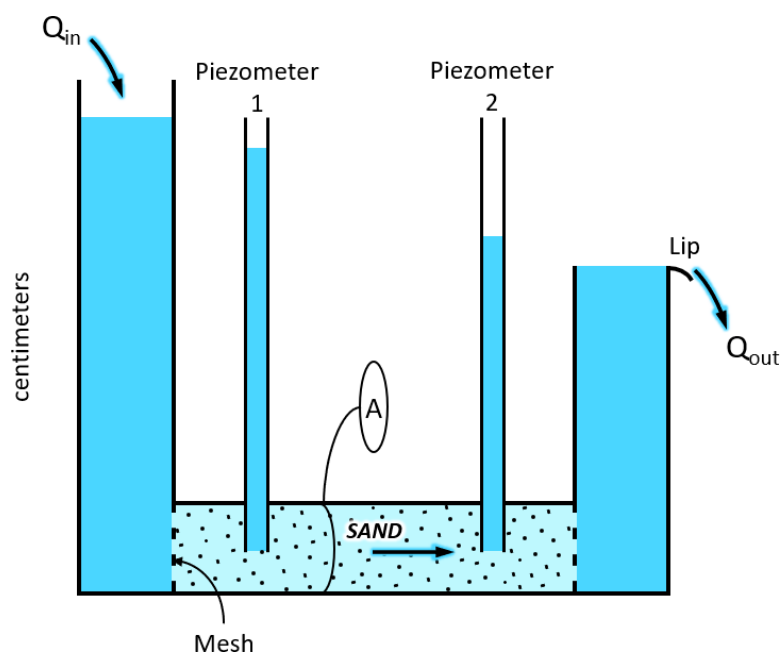

Figure 1 - Experimental apparatus for the illustration of Darcy's law. A is the cross-sectional area of the sand-filled cylinder, Q_{in} is the flow into the apparatus, and Q_{out} is flow out of the apparatus (Cohen and Cherry, 2020).

The apparatus consists of a cylinder of cross-sectional area, A , that is filled with a porous medium such as sand. Water is introduced slowly into the left vessel and gradually flows through the sand-filled cylinder until the pore spaces in the sand are fully saturated. The water levels in each vessel continue to rise until the water level in the right vessel reaches the top and begins to flow over the lip. In this way, although water continues to be introduced into the left vessel, the elevation of the water column on the right side remains fixed. The water level in the left vessel continues to rise until the inflow rate, Q_{in} , is equal to the outflow rate, Q_{out} , at which time the elevation in both vessels stabilize. That is, **steady-state** flow conditions are established, and Q is the volumetric flow rate of water through the cylinder (*i.e.*, volume per unit time, such as cubic meters per second, gallons per minute, liters per second).

Piezometers (in this case, small-diameter open tubes) are inserted into the cylinder. The upper end of each piezometer is open to the atmosphere, and the lower end is screened such that water can enter, but sand grains cannot. Upon insertion, the water level in each piezometer rises to a stable elevation. The elevation of the water measured in each piezometer represents the *hydraulic head* at the point of measurement, which in this case is the open end of the piezometer in the sand. Later, we will explore the various components of hydraulic head in porous media, which consists of the pressure at the point of measurement due to the water column above it, and the elevation of the point of measurement. As we will discuss further, *pressure measurements alone are not sufficient to evaluate groundwater conditions*.

Figure 2 is an abbreviated representation of the experimental setup that provides a framework to describe Darcy's law. If we set an arbitrary datum at elevation $z = 0$ (for example, mean sea level), the water elevations in the piezometers are h_1 and h_2 . The distance between the piezometers is ΔL .

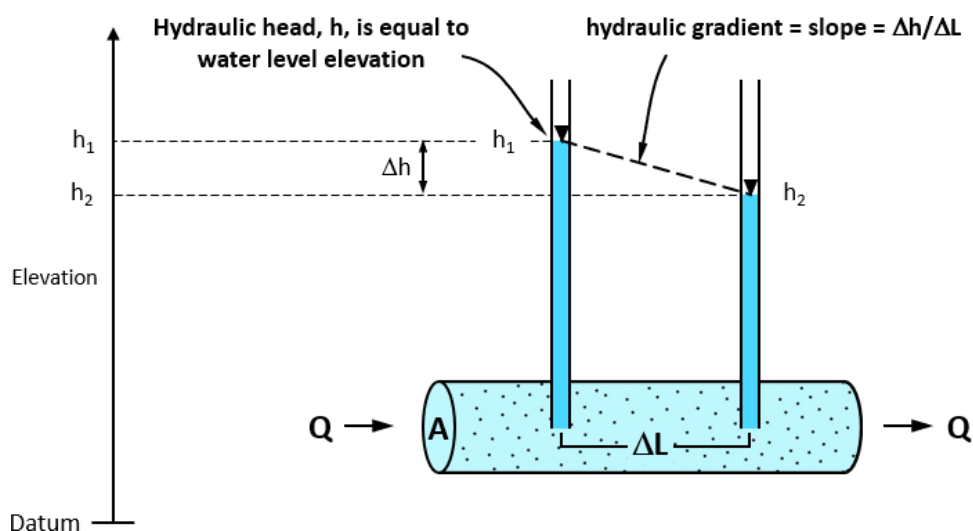

Figure 2 - Illustration of hydraulic gradient based on two measurement points. Hydraulic gradient is defined by the distance between the piezometers and the difference in hydraulic head (Cohen and Cherry, 2020).

Darcy's law (Equation 1) states that the volumetric flow rate, Q , is proportional to: (1) the difference in hydraulic head along a length interval, ΔL ; (2) a coefficient K (hydraulic conductivity), which accounts for restriction to flow imposed by the solid medium and for the density and viscosity of the fluid flowing through the porous medium (in this case, water through sand); and (3) the cross-sectional area perpendicular to the flow direction:

$$Q = -K \frac{(h_2 - h_1)}{\Delta L} A \quad (1)$$

The negative sign accounts for the fact that we define flow as positive in the direction of decreasing head (water flows from higher elevations to lower elevations). For example, in **Figure 2**, the term $h_2 - h_1$ is negative, so introducing the negative sign results in a positive value for Q .

The nature and properties of hydraulic conductivity are described in more detail in the [Groundwater Project book](#) by Woessner and Poeter (2020). The term $(h_2 - h_1)/\Delta L$ can be expressed more generally as the *hydraulic gradient* as shown in Equation 2.

$$\Delta h / \Delta L \quad (2)$$

Hydraulic gradient is often denoted with an i , which is represented by the slope of the dashed line in **Figure 2**. Darcy's law can therefore be expressed as Equation 3.

$$Q = -KiA \quad (3)$$

Darcy's law applies to laminar (non-turbulent) flow conditions, meaning that the rate of water flow is slow enough that the trajectories of water particles do not crisscross as they migrate through the interconnected voids of the porous media. By "water particle", we mean an aggregate of water molecules occupying a sufficiently small volume such that it can migrate through the interconnected network of pore spaces without separation. This volume may be on the order of cubic micrometers or less. Darcy's law is discussed in depth by Woessner and Poeter (2020).

Having established the basic relationship described as Darcy's law (Equation 3), note that the hydraulic gradient is independent of the absolute elevation of the water level. As shown in **Figure 3**, the gradient is based only on the relative difference in head and not on the magnitude of each head value.

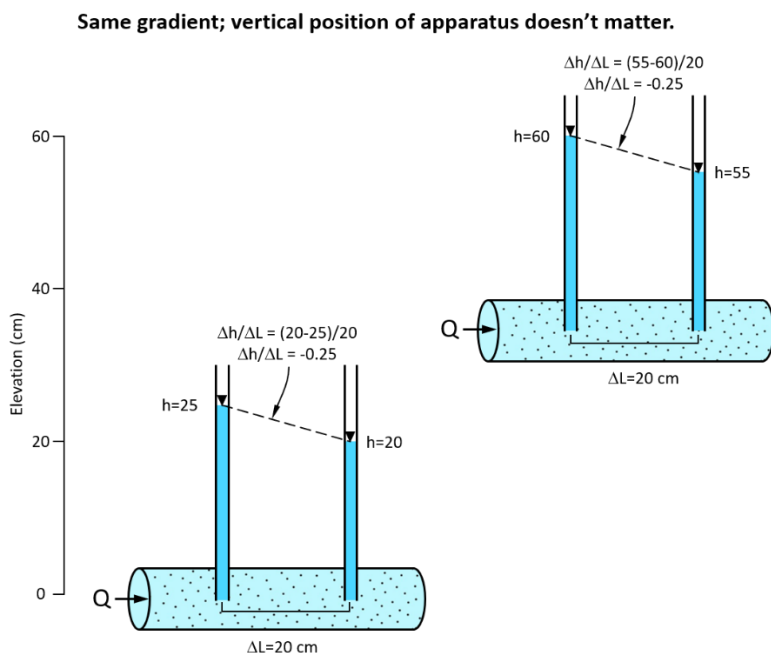

In addition, Darcy's law is independent of the orientation of the apparatus, because flow occurs in the direction of the hydraulic gradient. For example, as shown in **Figure 4**, the magnitude of the hydraulic gradient is the same in each case and the flow direction is always parallel to the apparatus.

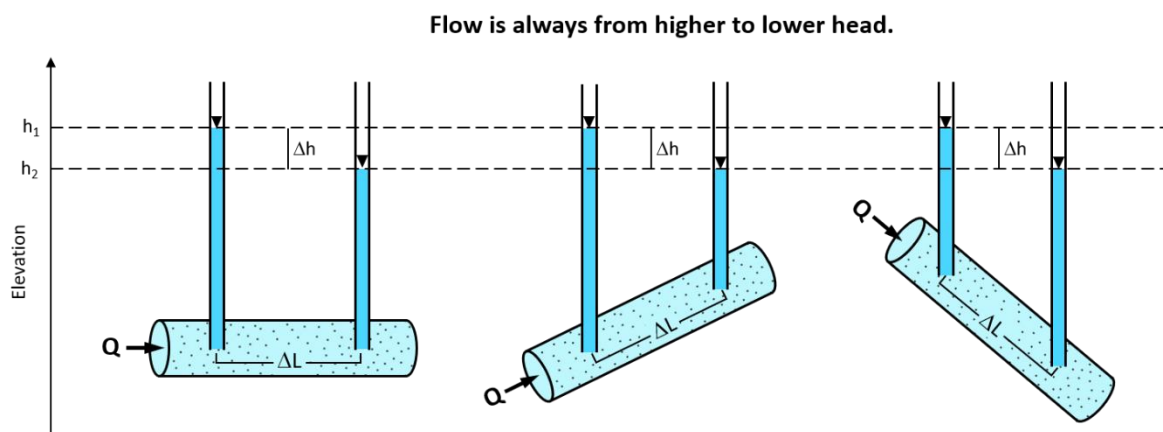

Figure 4 also illustrates an important aspect regarding how we interpret hydraulic gradient measurements, and it is worth noting early on. In the cases shown above, the gradient is defined with reference to ΔL , which is the distance between the measurements *along the flow path*. However, in practice, when we measure water levels in existing wells or

install new wells to measure hydraulic gradient, we may not know the flow direction (in fact, flow direction is one of the most fundamental characteristics of groundwater we are trying to ascertain). Consider the various cases shown in **Figure 4**; if we were unable to observe the orientation of the cylinder, all we could deduce from the head measurements is that there is some *component* of flow in the horizontal direction (towards the right), and it is clearly possible that the flow could also have an upward or downward component. In fact, we can imagine the case where the inclination of the cylinder is even steeper than the cases shown, such that flow could be nearly vertical. This mental exercise points out a critical consideration needed to interpret hydraulic head data to infer flow direction. That is, we need to have some knowledge or assumptions regarding other factors that affect flow. In this case, it is the orientation of the confining boundaries (i.e., the sides of the cylinder); such knowledge provides a framework upon which we can interpret the head data. Later in this book, we discuss other factors regarding interpretation of water level elevations in wells, such as spatial variation of hydraulic conductivity and the location and type of recharge and discharge zones, because these must be considered in order to properly interpret hydraulic head data.

2.2 Hydraulic Head Gradient as a Manifestation of Other Variables and Conditions

Hydraulic gradient ($\Delta h/\Delta L$) is often expressed mathematically in differential format as dh/dL . Rearrangement of Darcy's law using this formulation shows that hydraulic gradient is a function of Q , K , and A :

$$-\frac{dh}{dL} = \frac{Q}{KA} \quad (4)$$

Therefore, a change in any one of these variables will manifest as a change in hydraulic gradient:

$$-dh/dL \propto Q \quad (5)$$

$$-dh/dL \propto 1/K \quad (6)$$

$$-dh/dL \propto 1/A \quad (7)$$

The negative sign is due to the fact that water flows in a direction from higher head to lower head, as described previously. The term $-dh/dL$ represents the slope of the head decline in the direction of flow (the "steepness" of the hydraulic gradient).

Figure 5 summarizes this concept using three different, yet spatially-uniform scenarios. The hydraulic gradient, which is commonly measured by way of water levels in wells, is not the controlling parameter that dictates flow. Rather, hydraulic gradient is a manifestation of the combined effects of the system geometry, hydrogeologic properties and the flow rate imposed on the system.

Lower K causes steeper gradient

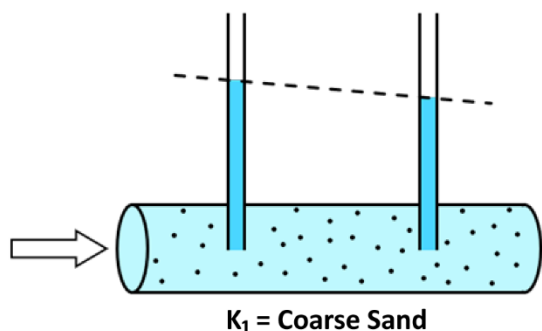

Hydraulic gradient is steeper, because

$$-dh/dL \propto 1/K$$

and $K_2 < K_1$

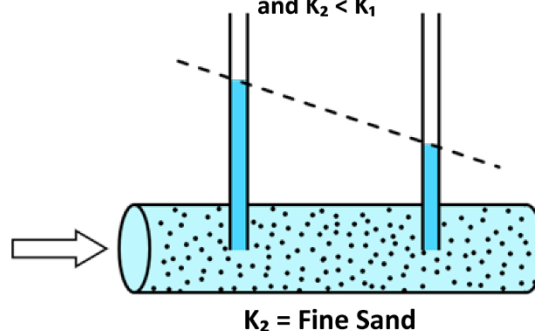

Higher Q causes steeper gradient

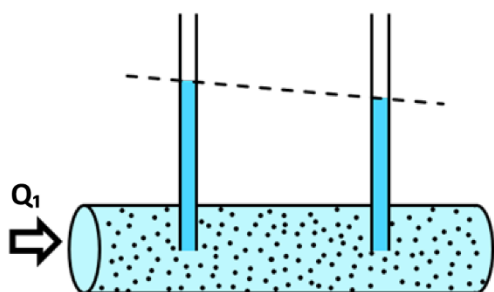

Hydraulic gradient is steeper, because

$$-dh/dL \propto Q$$

and $Q_2 > Q_1$

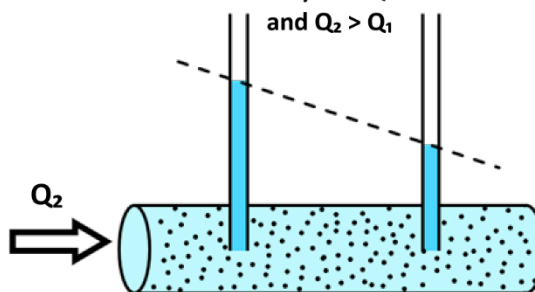

Smaller area causes steeper gradient

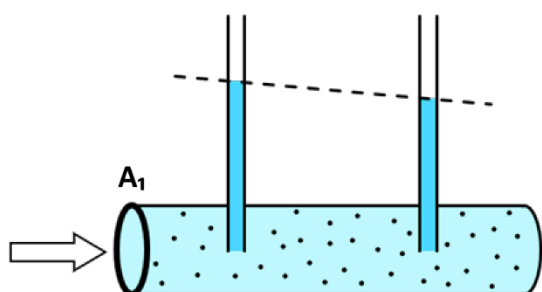

Hydraulic gradient is steeper, because

$$-dh/dL \propto 1/A$$

and $A_2 < A_1$

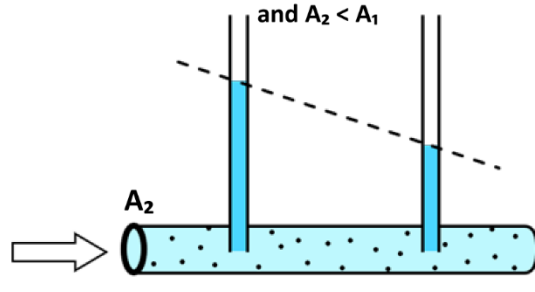

Figure 5 - Illustration of hydraulic gradient dependence on hydraulic conductivity, flow rate, and area. In each case, the gradient changes in accordance with the proportionality relationship defined by Darcy's law (Cohen and Cherry, 2020).

In the example shown in **Figure 6**, $K_2 < K_1$ whereas Q and A are constant. Q is the same at every location along the tube because mass is conserved. Therefore, as indicated by Darcy's law, the gradient in the region of K_2 must be steeper than in the other regions. This simple scenario is an example of a heterogeneity; in this case, hydraulic conductivity is not uniform.

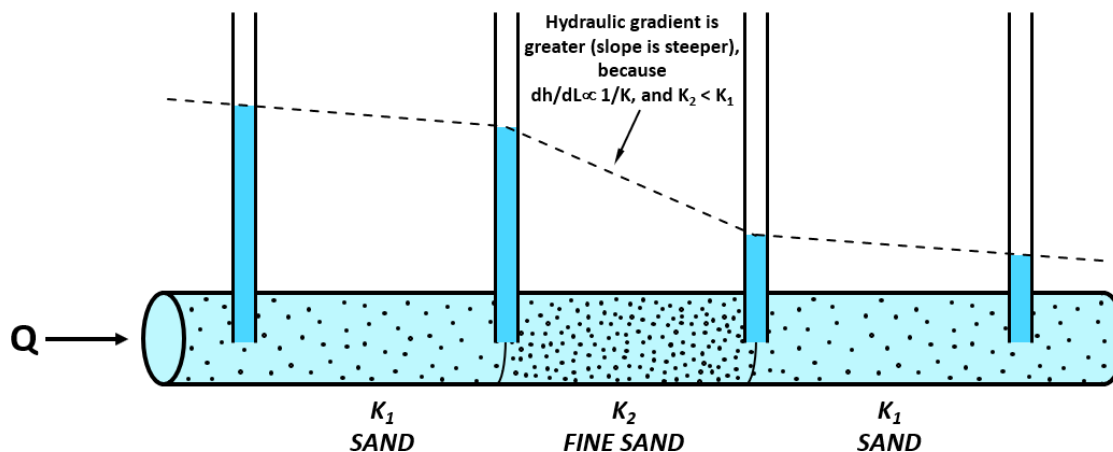
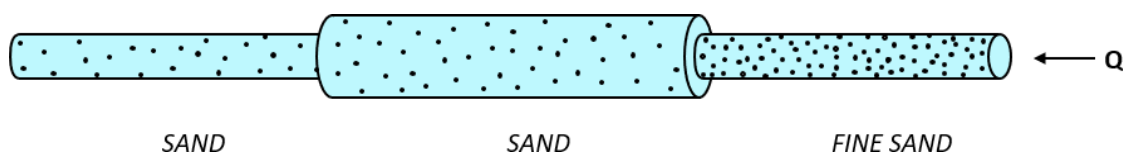

Figure 6 - Change in hydraulic gradient due to variable hydraulic conductivity. In this case, the gradient is steeper in the section with lower K , since gradient is inversely proportional to K (Cohen and Cherry, 2020).

Example Problem 1

Sketch the horizontal hydraulic head gradient along the length of the apparatus shown here in a manner similar to the way the gradient is shown in **Figure 6** (there is no need to know the actual head values, so you can create your own relative values).



[Click here for solution to Example Problem 1](#)

2.3 Components of Hydraulic Head

Figure 7 is a modification of the experimental setup described previously and illustrated in **Figure 1**. If water was no longer introduced into the left vessel, the water level in the left vessel would gradually decline, the hydraulic gradient would lessen, and flow through the cylinder (Q_{out}) would also gradually decline in accordance with Darcy's law. These time-dependent flow conditions are referred to as *transient conditions*, which are relevant to groundwater modeling and pumping tests, for example. In the transient scenario depicted in **Figure 7**, both h_1 and Q_{out} can be expressed as a function of time, $f(t)$,

often denoted as $h_1=f(t)$ and $Q_{out}=f(t)$. Eventually, the water levels on both sides will equilibrate, the hydraulic gradient will equal zero, and thus water will no longer flow through the cylinder. The water is static everywhere.

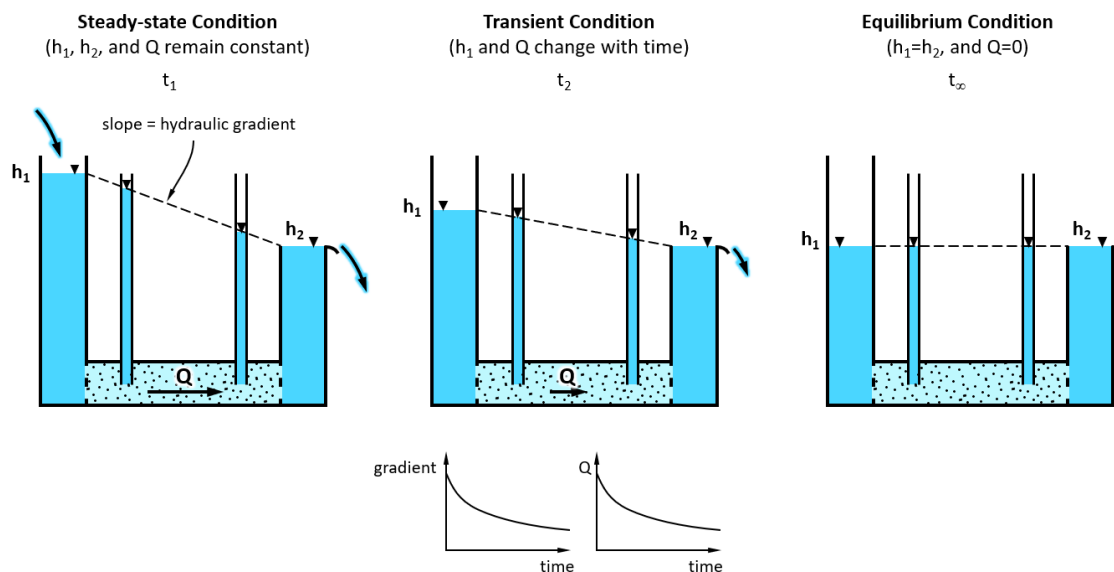

Figure 7 - Various hydraulic head and flow conditions. Steady-state flow (t_1) and hydraulic equilibrium conditions (t_∞) define constant flow and no flow, respectively, whereas the intermediate state (t_2) is transient in that conditions change over time (Cohen and Cherry, 2020).

Referring to the hydraulic equilibrium condition (t_∞) in **Figure 7**, imagine inserting piezometers into the vessel to various depths (**Figure 8**). The water in all the piezometers will rise to the same elevation that is equal to the water level elevation in the vessel. This may be intuitively obvious, since it is analogous to inserting straws into a glass of water: no matter to what depth a straw is inserted, the water level inside the straw will be equal to the water elevation in the glass. Note that if the straws were sufficiently small in diameter, water may be drawn upward above the surrounding water level due to capillary action; however, in practice the diameter of wells (field-scale piezometers) are not small enough to create a significant capillary effect. Since the *point of measurement is the open end of the piezometer in the water*, this exercise shows that the hydraulic head is the same everywhere and that the hydraulic head measured at the open end of the piezometer is equal to the elevation to which the water rises. **Figure 8** shows the resulting head distribution; the hydraulic head is 5 cm everywhere, regardless of the depth of the measurement. Hydraulic head distribution is discussed in more detail in Section 3 and 4 in the context of developing hydraulic head contour maps and potentiometric cross sections, which are used to infer the direction and magnitude of groundwater flow.

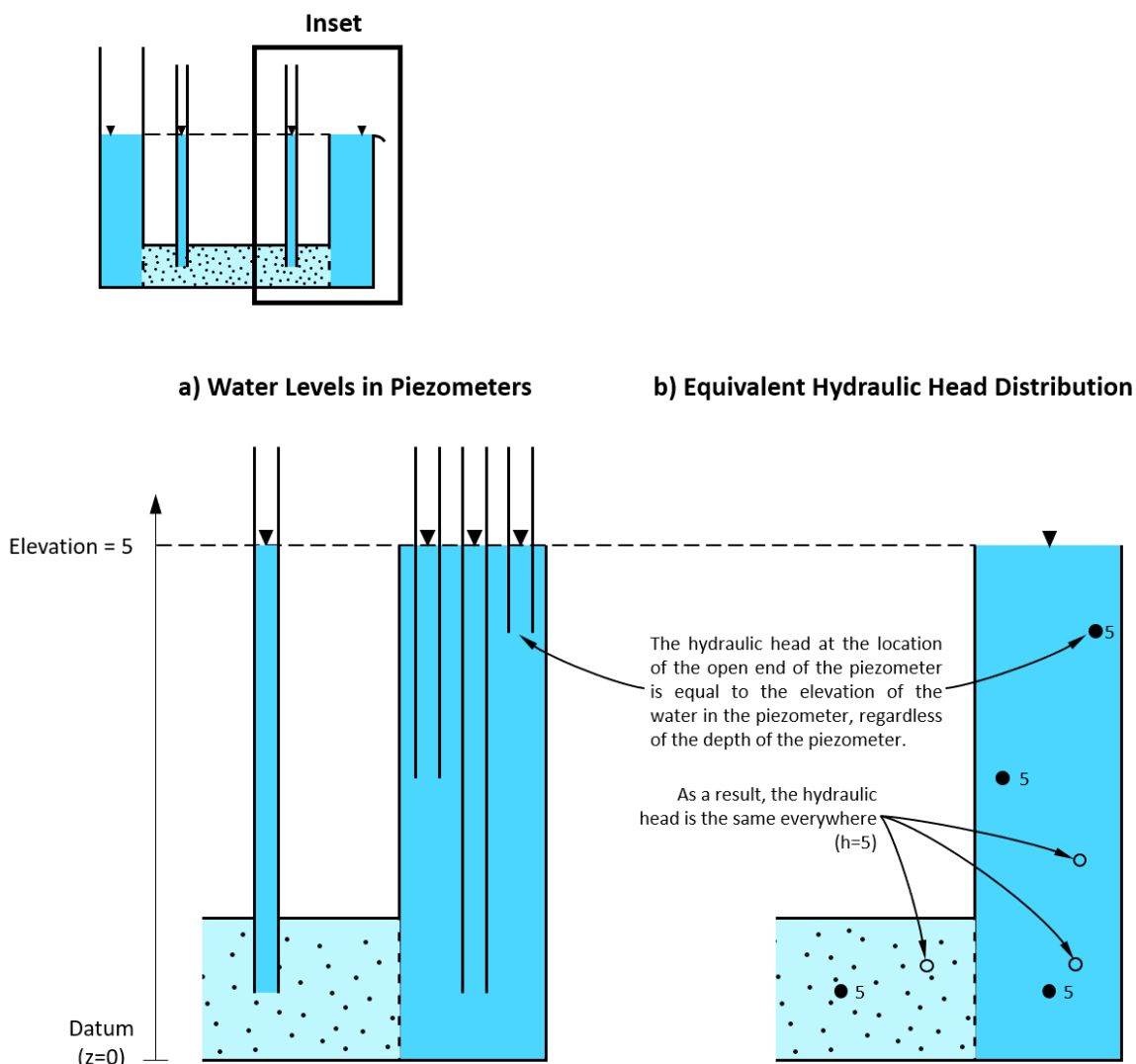

Figure 8 - Use of piezometers to measure the hydraulic head distribution; in this case, the hydraulic head is the same everywhere, as evidenced by the same water level elevation in each piezometer (Cohen and Cherry, 2020).

Figure 9 shows the components of hydraulic head in a static vessel of water. The hydraulic head (h) at each location is the sum of the elevation of the point of measurement and the height of the water column above that point. Since the latter is proportional to the pressure of the water column, it is often referred to as the pressure head (Ψ), whereas the elevation of the point of measurement is referred to as the elevation head (z):

$$h_i = \Psi_i + z_i \quad (8)$$

With regard to flow in the saturated zone, the elevation of the water level in the piezometer is what is of interest, and that is what the reader should be sure to understand: *the hydraulic head in a saturated formation is equal to the elevation of the water that rises in a well, which is effectively a piezometer.*

The hydraulic head in **Figure 9** is the same everywhere. Accordingly, the hydraulic gradient is zero everywhere such that the water elevation in piezometers will be equal.

However, the pressure head (Ψ) in the piezometers is different (they are proportional to the height of the water column in each piezometer). This simple setup illustrates that pressure head should not be used to infer flow.

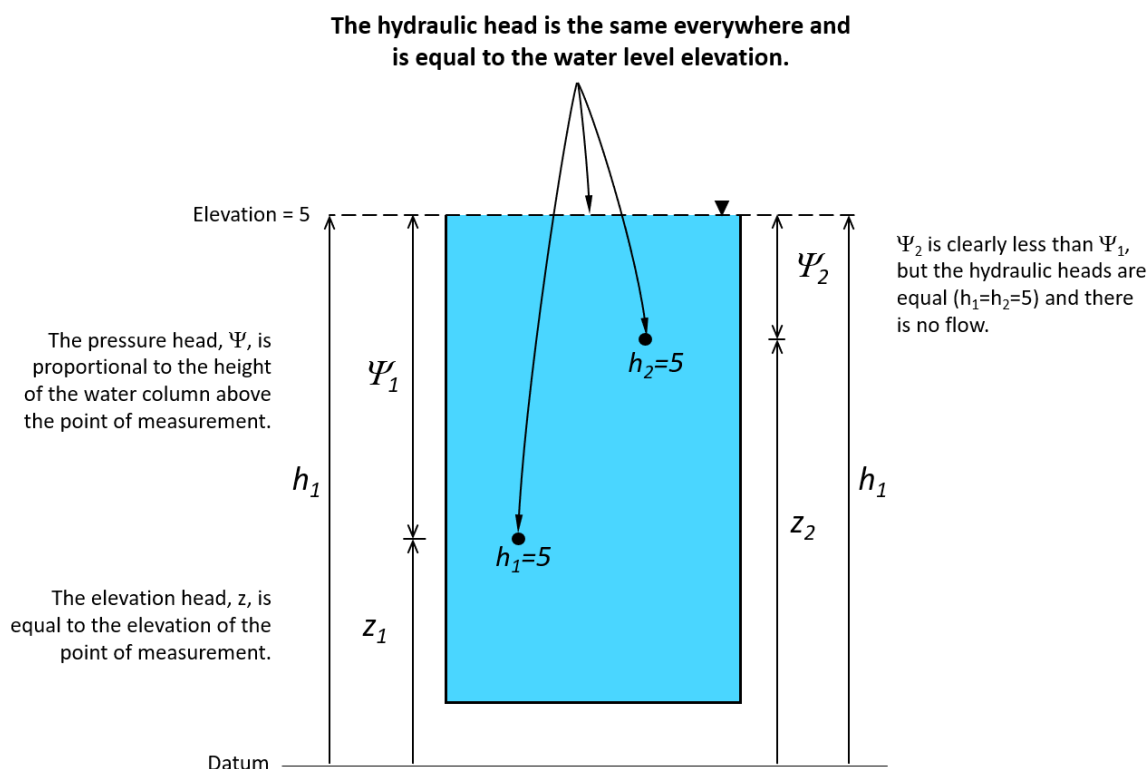

Figure 9 - Hydraulic head at a particular location is a function of the elevation of the point of measurement (z) and the height of water above the point of measurement (Ψ); Each point is at a different elevation, but they have the same hydraulic head because the components of pressure head and elevation head add to 5 in both cases ($h_1=h_2$), which is also equal to the elevation of the free water surface (Cohen and Cherry, 2020).

The same principle applies to flowing conditions. For example, **Figure 10** shows that the direction of decreasing pressure head (Ψ) in each configuration is the opposite of one another, but the direction of flow and hydraulic gradient is the same for each scenario. Hence, **Figure 10** shows quite clearly that the flow direction cannot be based on the pressure head alone, but requires evaluation of the hydraulic head, which is defined by water elevation in the piezometers.

Flow direction only depends on the hydraulic gradient, not the pressure gradient

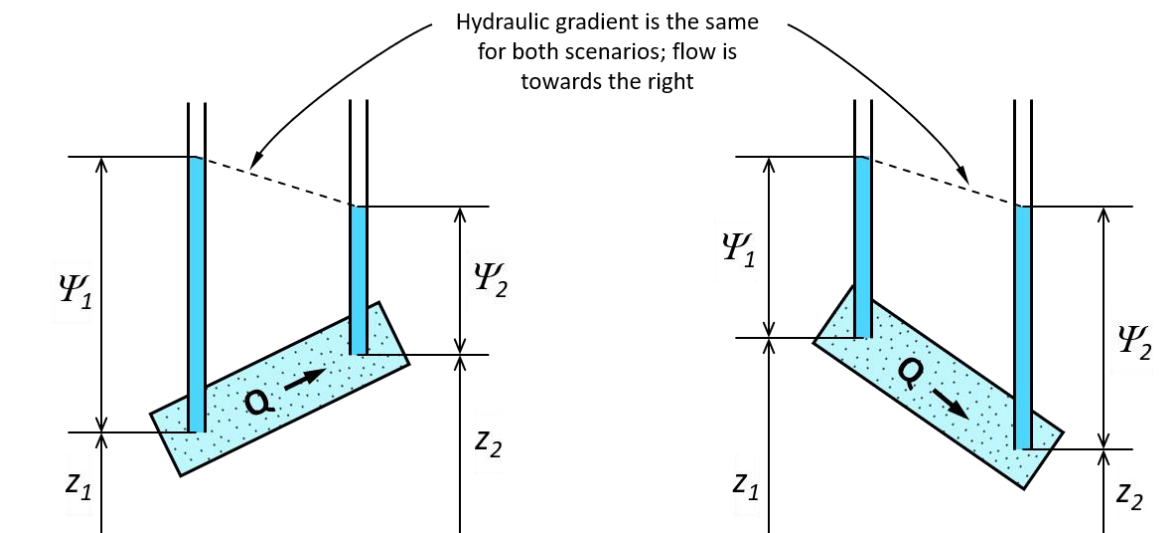
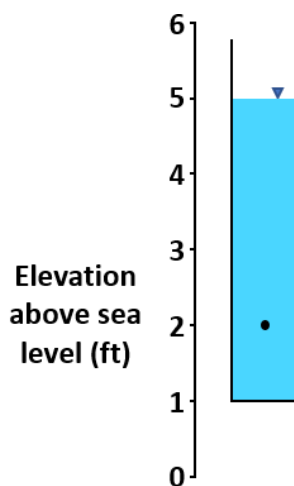

Figure 10 - Apparatus demonstrating that changing the slope of a sand-packed cylinder changes components of elevation and pressure heads, but the hydraulic heads, hydraulic gradient, and the direction and rate of flow remain the same (Cohen and Cherry, 2020).

Example Problem 2

What is the hydraulic head at the point in the column shown below?

- a. 1 ft
- b. 2 ft
- c. 3 ft
- d. 4 ft
- e. 5 ft



[Click here for solution to Example Problem 2](#)

3 Darcian Head Profiles

Let us again consider a steady-state scenario shown in **Figure 11a**. In this case, the water level in both vessels remain fixed such that either side of the cylinder of porous media is bounded by a constant hydraulic head, and the difference in hydraulic head drives the flow (that is, water flows from a region of higher potential energy to a region of lower potential energy). In accordance with Darcy’s law, there is a hydraulic gradient in the porous medium, and the water is flowing from left to right, as expressed by the hydraulic gradient, which is equal to -0.4 m/m , as shown on the head profile (**Figure 11b**).

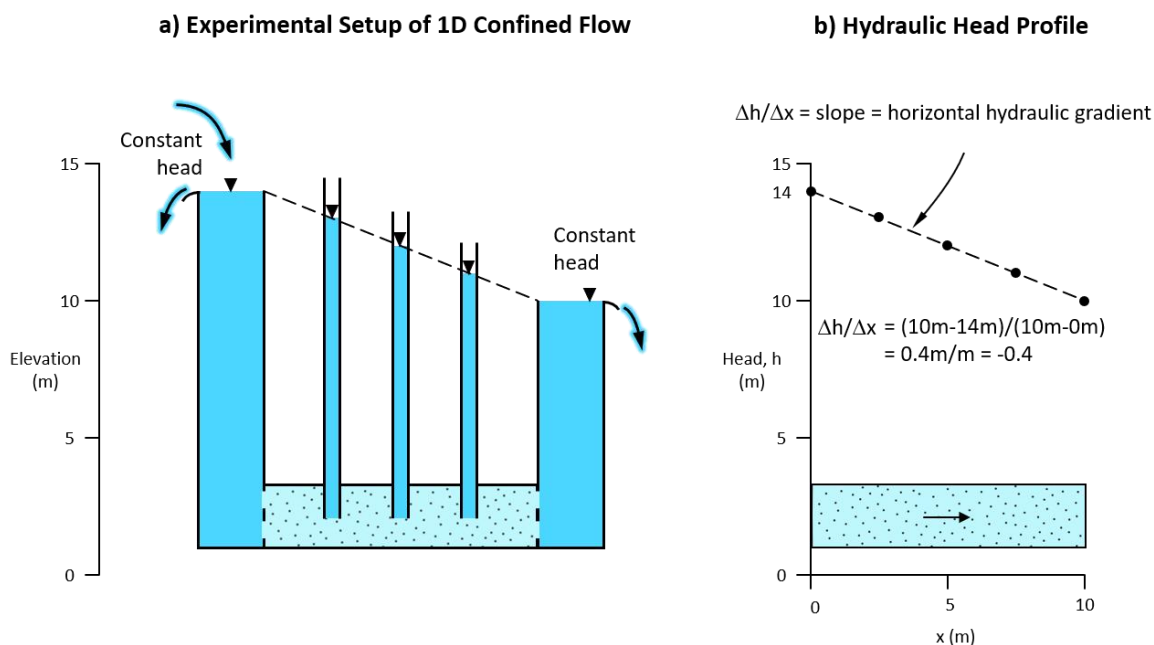

Figure 11 - Demonstration of steady-state horizontal flow and associated horizontal gradient; water flows left to right in accordance with the direction of decreasing potential energy, as expressed by the hydraulic head profile: a) experimental setup and b) hydraulic head profile (Cohen and Cherry, 2020).

Note that the hydraulic head within each column of water is uniform with depth as shown in **Figure 12** and as described previously. The hydraulic head at each point of measurement in the piezometer is equal to the elevation of the top of the water column in the piezometer. In theory, there is negligible (and perhaps immeasurable) vertical hydraulic head gradient in each vessel, because there is also vertical flow in the vessel, but the differences in head throughout the vessel are insignificant given the slow flow rate and minimal friction imparted by the sides of the vessels. Thus, for all practical purposes, the head profile can be considered uniform in each water column.

This experimental setup provides an opportunity to introduce some simple hydraulic modeling concepts, depicted as the equivalent hydraulic model (**Figure 12c**).

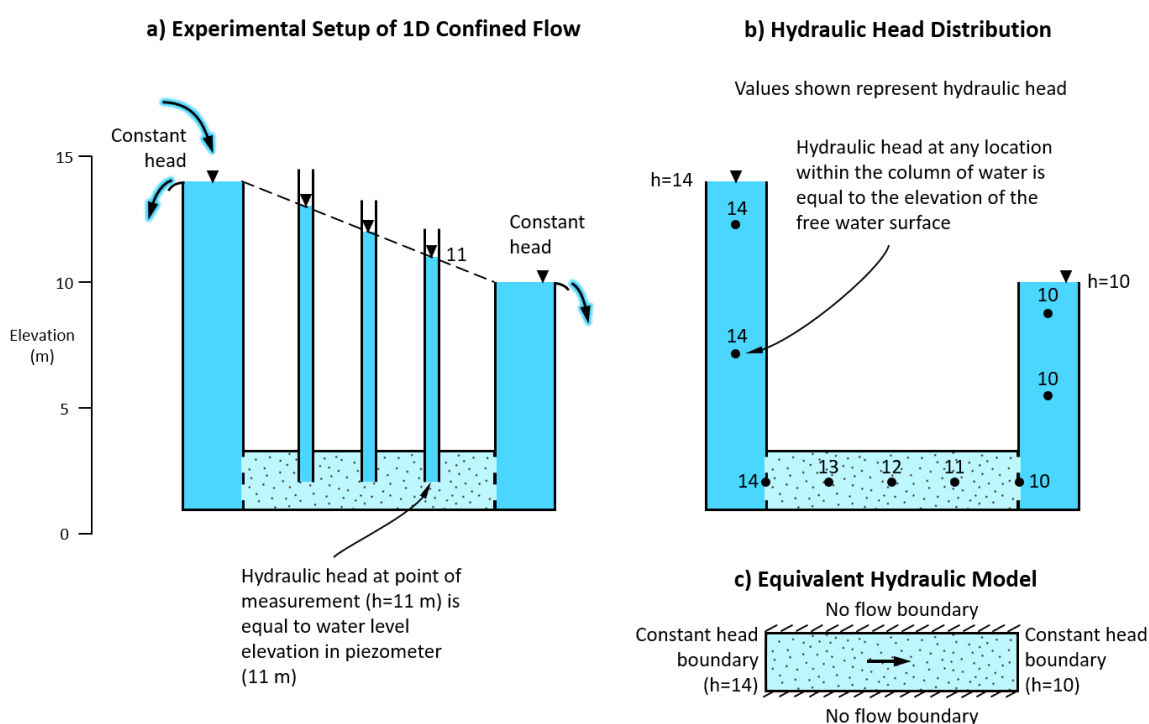

Figure 12 - Relationship between piezometer measurements, hydraulic head distribution, and associated boundary conditions of the experimental setup. This is a steady-state scenario for a system with constant head boundaries (Cohen and Cherry, 2020).

Figure 13a shows the same experimental setup, except the cylinder of sand is vertical. As such, plotting hydraulic head as a function of elevation is appropriate (**Figure 13b**). Hydraulic head decreases with decreasing elevation. As a result, the hydraulic gradient is positive (+0.4), whereas the gradient was negative (-0.4) in the horizontal setup (**Figure 11**). This difference in sign is simply an artifact of using elevation as the spatial coordinate; Darcy's law still applies, and *water flows downward in the direction of decreasing hydraulic head*.

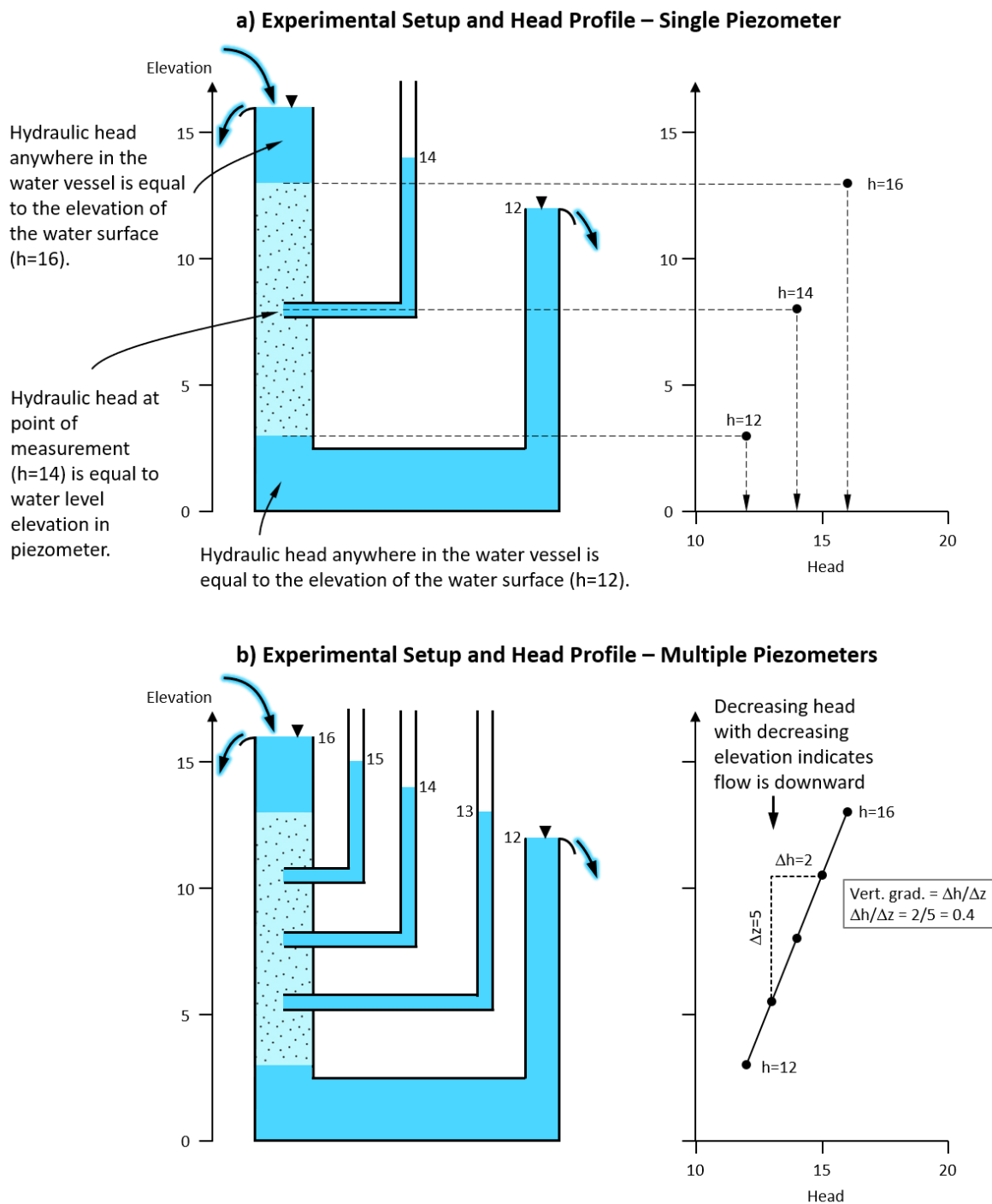

Figure 13 - Demonstration of vertical flow and associated head profile: The head profile is defined by water levels measured in piezometers and their respective points of measurement, which are the open ends of each piezometer in the sand column. Water flows downward, from higher head to lower head (Cohen and Cherry, 2020).

Figure 14 is a modified version of the multi-piezometer experimental setup shown in **Figure 13b**. In the case of **Figure 14**, the piezometers are “nested” in that they are closely spaced but measure the head at different depths because the open end of each piezometer (the point of measurement) is located at different elevations.

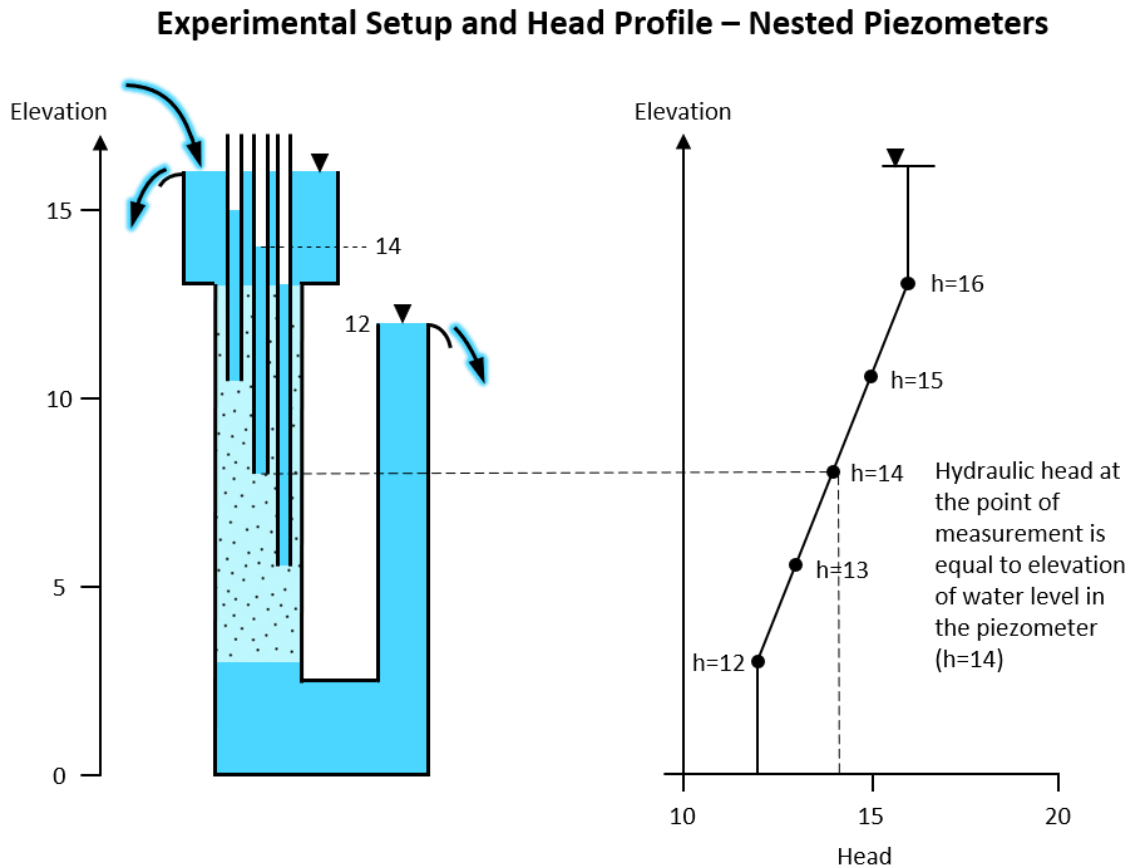

Figure 14 - Head profile using nested piezometers. Even though the piezometers are positioned close to one another and their respective water levels decrease towards the right, the measurements are actually representative of the vertical head profile, because all flow is vertical owing to the geometry of the cylinder, and the vertical position of each point of measurement is different (Cohen and Cherry, 2020).

Figure 15 compares the head profiles measured with the piezometers in **Figure 13b** to the nested piezometer configuration (**Figure 14**). The head profiles are identical, because the points of measurements and the boundary conditions are identical.

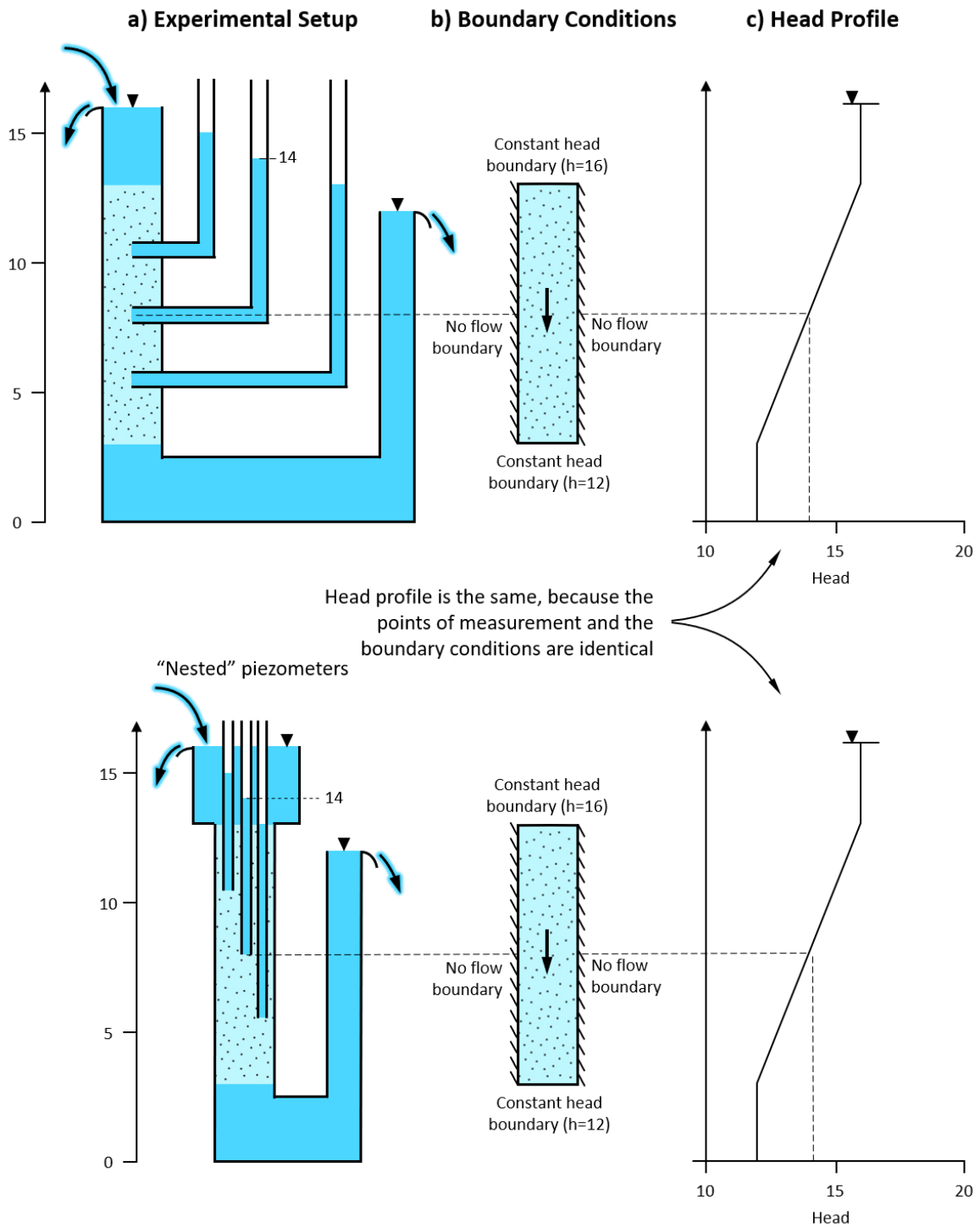

Figure 15 - Comparison of head profile using different piezometer orientations: a) experimental setup; b) boundary conditions; and, c) head profile. The head profiles are identical, because the points of measurement and the boundary conditions are identical (Cohen and Cherry, 2020).

Figure 16 illustrates vertical hydraulic gradients for downward and upward one-dimensional flow. The relationship between hydraulic gradient and hydraulic conductivity, K , ($-dh/dL \propto 1/K$) still holds; only the orientation has changed.

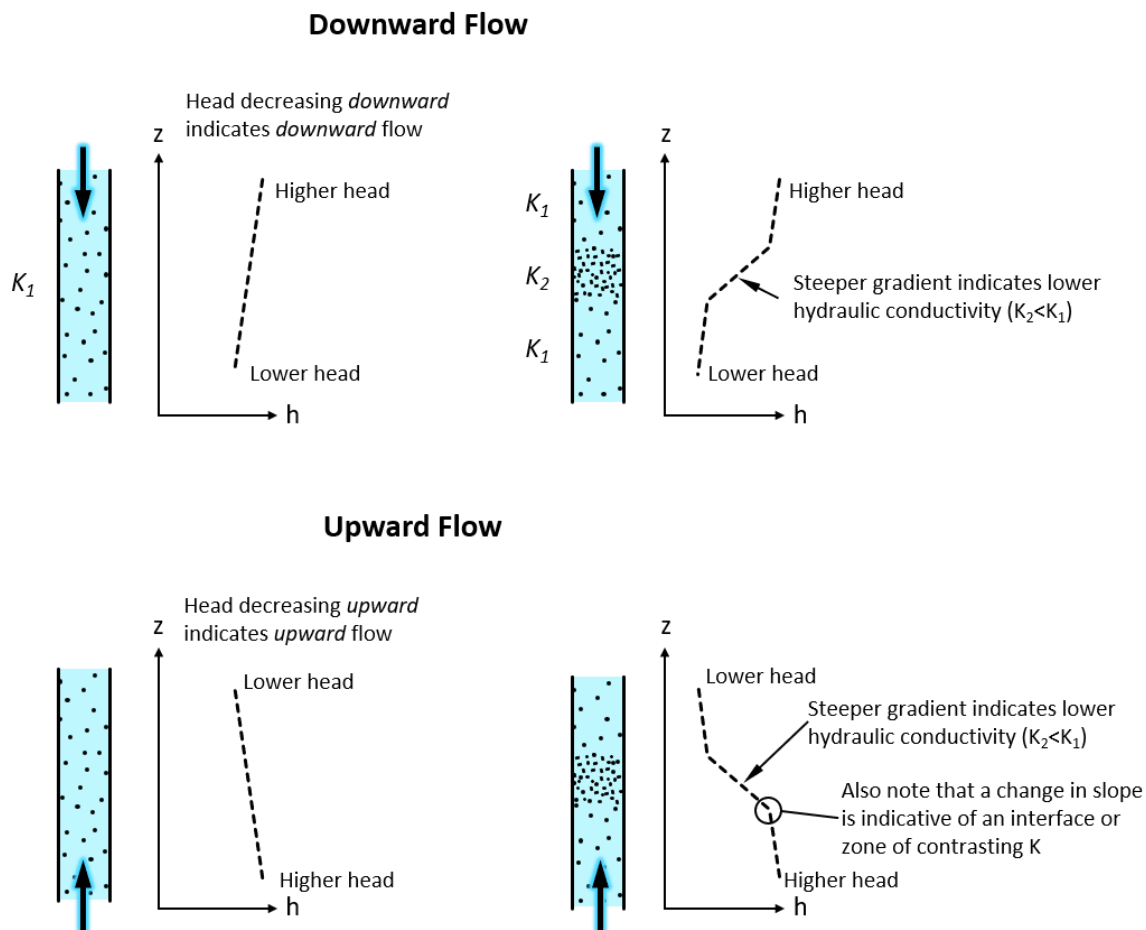

Figure 16 - Vertical head profiles for downward and upward flow scenarios. The head profile defines the direction of flow, and changes in slope are indicative of variable hydraulic conductivity (Cohen and Cherry, 2020).

4 Equipotential Lines and Flow Direction

Having established the concept of hydraulic gradient and the fact that groundwater flows from locations of higher head to regions of lower head, the objective of this section is to introduce how hydraulic gradients manifest in the form of equipotential lines, which are commonly plotted as *equipotential contours* on maps and in cross section. These, in turn, provide a means to infer the direction and magnitude of hydraulic gradients and flow directions. Understanding how to create and interpret equipotential contour maps and equipotential contour cross sections is essential to successful management of groundwater resources.

This section can serve as an introduction to flow nets. Graphical construction of flow nets is presented in the [Groundwater Project book](#) [↗] by Poeter and Hsieh (2020) in which the general characteristics of equipotential lines and associated flow directions are introduced for various idealized hydrogeologic conditions. This book discusses hydraulic head profiles as they relate to contours of equipotential as illustrated in cross sections.

The discussion of equipotential lines, flow directions, and gradients presented in this section is valid for isotropic conditions ($K_x=K_y=K_z$), which means hydraulic conductivity has the same value when measured in any direction. This simplification is not a compromise, rather it enables us to more easily understand the underlying concepts that form the basis for more complex situations. In fact, when analyzing hydrogeologic systems in the field, we often assume isotropy in the initial analysis, and it is not always necessary to go beyond this simplification. This assumption may be loosened to account for anisotropic conditions, in which K is not the same in all directions (Woessner and Poeter, 2020).

4.1 General Considerations

Let us first consider a simple experimental setup to illustrate some of the most fundamental aspects of equipotential contours and associated flow directions (for an isotropic medium). As shown in **Figure 17**, piezometers are inserted to various depths on either side of a horizontal cylinder filled with water-saturated, porous medium through which water flows under laminar conditions (in other words, water is flowing according to Darcy's law). Since the water level in a piezometer represents the hydraulic head *at the point of measurement* (the open end at the bottom of each piezometer), the hydraulic head at all three points on the left side ($x_1=10$ cm) is equal to 20 cm ($h_1=20$ cm). Similarly, the hydraulic head at all three points on the right side ($x_2=40$ cm) is 14 cm ($h_2=14$ cm). As shown in **Figure 17b**, an *equipotential contour connects points of equal hydraulic head*. Stated differently, *the hydraulic head at all points along an equipotential contour are equal*. Accordingly, there is no gradient along the equipotential contour and the *hydraulic gradient vector* must be orthogonal (i.e., at 90°) to the contour line. In other words, the flow direction is orthogonal to equipotential contours for isotropic conditions.

a) Experimental Setup

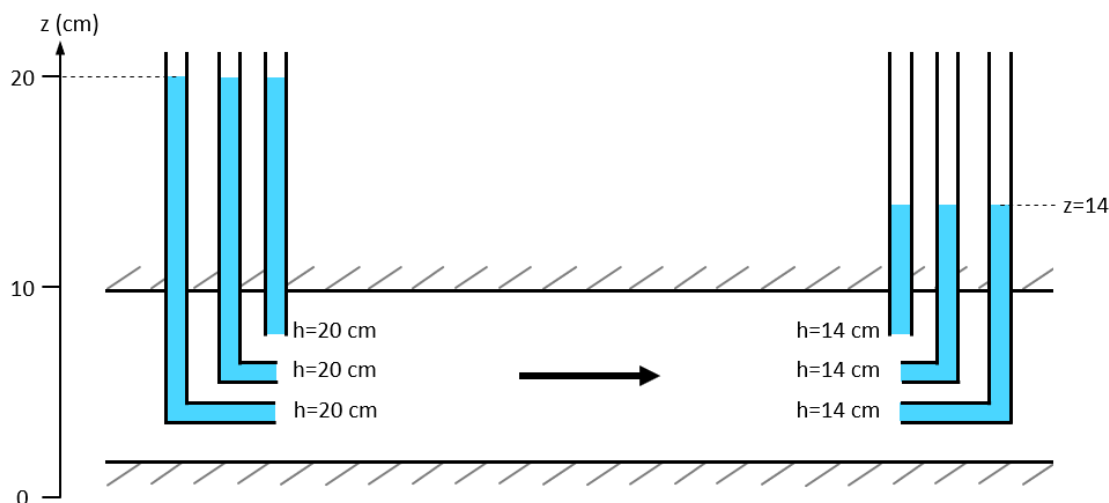

b) Hydraulic Head Profile, Gradient, and Equipotential Contours

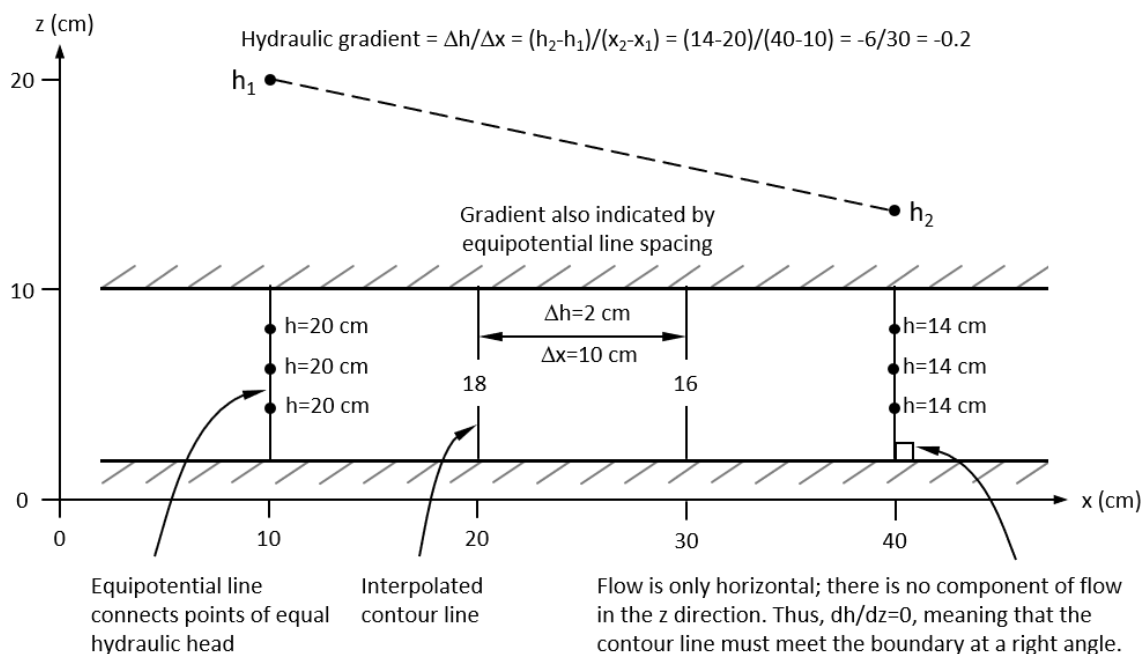

Figure 17 - Hydraulic head and equipotential contour lines for 1D flow: a) experimental setup and b) hydraulic head profile, gradient, and equipotential contour lines. Piezometer measurements enable definition of equipotential contours, which reflect the direction of flow (towards the right from higher head to lower head) and the hydraulic gradient (Cohen and Cherry, 2020).

The measurements at each location show that the hydraulic gradient in the z direction is zero. That is, hydraulic head does not change in the z direction ($\Delta h / \Delta z = 0$), which is consistent with the fact that water cannot flow in the vertical direction due to the presence of the impermeable sides (“no-flow boundaries”) of the horizontal cylinder. The

absence of a vertical gradient adjacent to the boundaries is expressed by equipotential lines that are perpendicular to the no-flow boundaries.

Figure 17 also shows the horizontal hydraulic head profile (horizontal hydraulic gradient). Note that hydraulic gradient can be measured using the head profile and by using the equipotential contours.

If the difference in head between the sets of piezometers was less, the hydraulic gradient would be smaller (hydraulic head profile would not be as steep and spacing between the 2-cm equipotential contour lines would be larger).

Example Problem 3

- Draw equipotential lines in the sand at 1 ft intervals.
- To what level will water rise in the hypothetical piezometer?

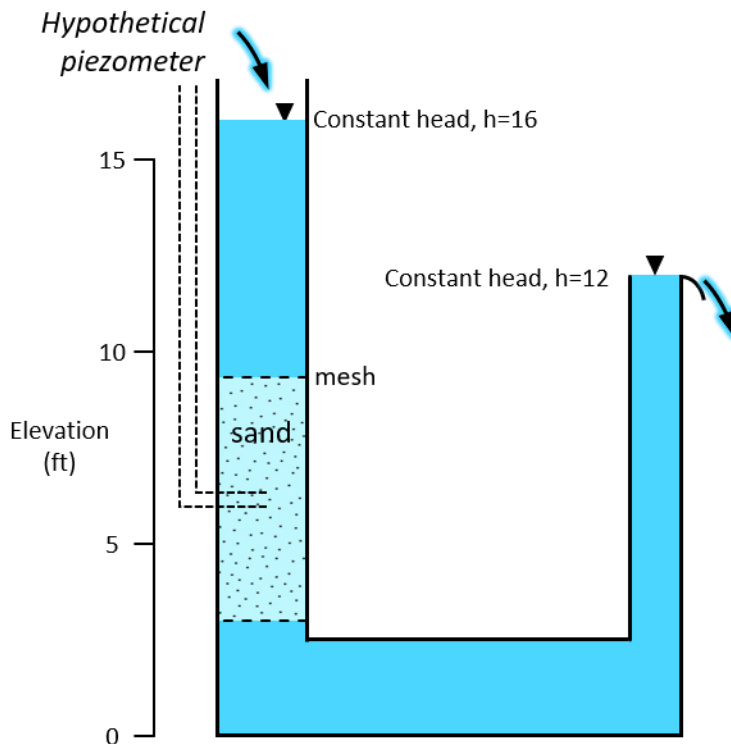

[Click here for solution to Example Problem 3](#) ↴

Having now established the basic elements of equipotential contours for one-dimensional flow and the associated groundwater flow direction, consider the experimental setup and corresponding hydraulic representation of two-dimensional flow in **Figure 18**. The overall flow geometry is as we would expect given that, based on the heads at the constant head boundaries, flow is left to right, and there needs to be at least some vertical component of flow owing to the geometry of the enclosed system and the location of the boundary conditions. As before, the equipotential contours meet the no-flow boundaries at right-angles. In addition, the equipotential contour lines at the constant head boundaries are defined by the elevation of the water body at those boundaries, which was illustrated in **Figure 12**. Note also that because the porous medium is isotropic, the flow lines meet the equipotential contours at right angles (90°).

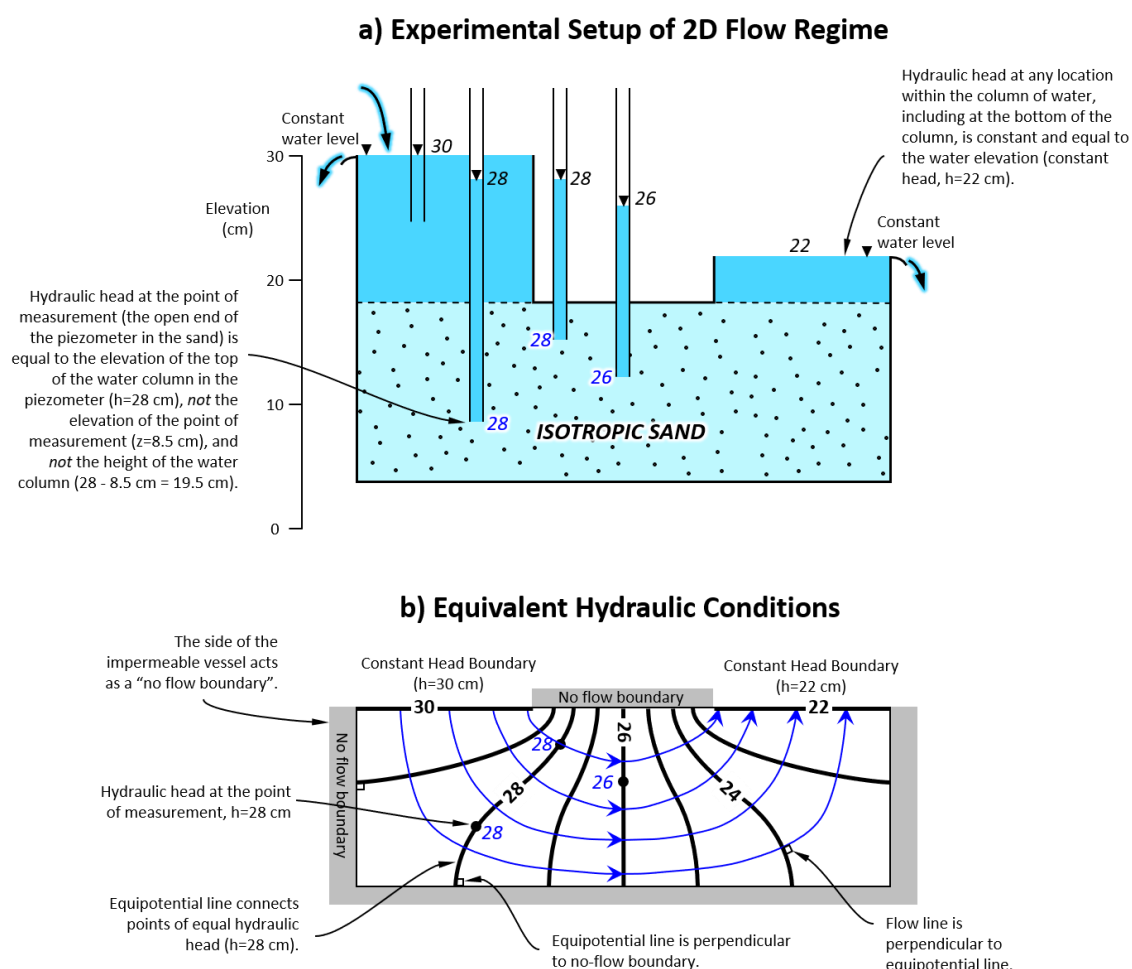

Figure 18 - Experimental apparatus to illustrate 2D flow: a) experimental setup of two-dimensional flow regime and b) equivalent hydraulic conditions. Boundary conditions are indicative of the experimental setup, and the relative location and type of boundaries dictates the flow geometry and associated equipotential contours (Cohen and Cherry, 2020).

5 Saturated Steady Flow at the Field Scale

On a field scale, hydraulic head can be measured using various types of wells (either installed separately, in a spatially clustered arrangement, or at the same horizontal location but at varying depths). Groundwater wells are essentially large-scale versions of the laboratory-scale piezometers we have used to illustrate Darcy's law in the preceding sections. The following sections present the relationship of hydraulic head and flow in three basic types of hydrogeologic formations (confined aquifer, aquitard, unconfined aquifer) in the saturated zone, as described in this section and shown in **Figure 19**.

A *confined aquifer* is bounded above and below by an *aquitard*, which is a semi-pervious formation that restricts flow between the overlying and/or underlying aquifers.

The water level elevation in a well screened in a confined aquifer will be higher than the base of the overlying aquitard. Interpolation of the water elevations between those measured in wells in a confined aquifer defines the *potentiometric surface*.

An *unconfined aquifer* is bounded only at its base by an aquitard. The top of the unconfined aquifer is the *water table*, which is the elevation of the water level in a screened well that is just deep enough to encounter standing water.

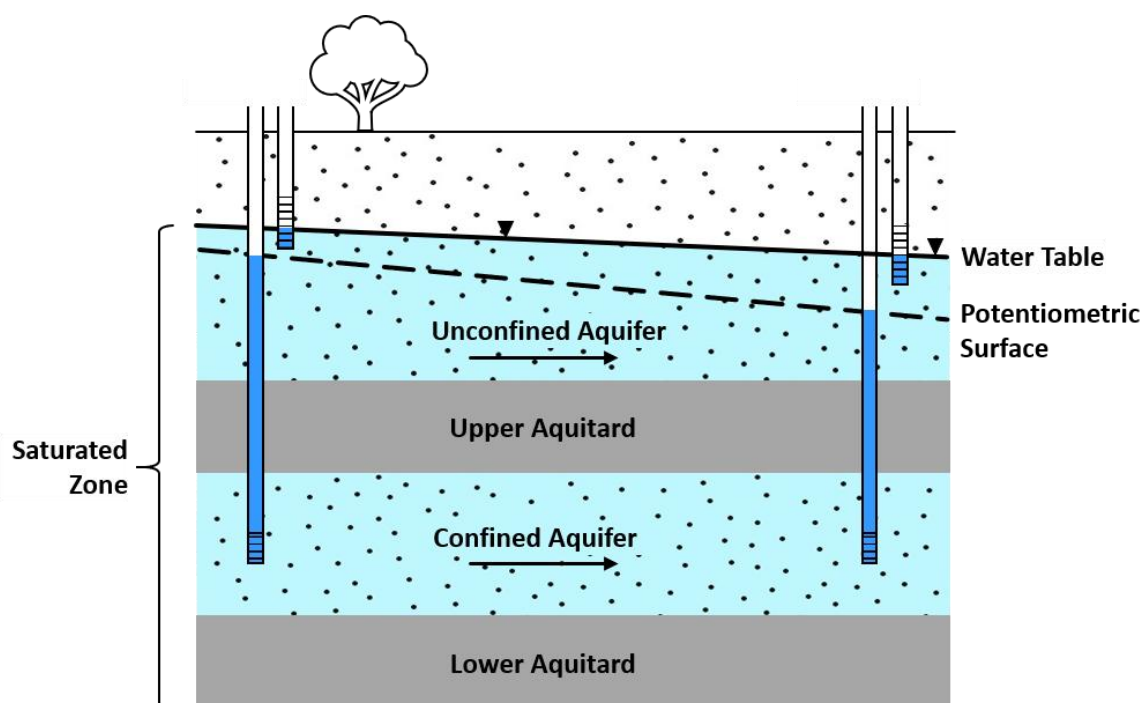

Figure 19 - Schematic cross section of an unconfined and confined aquifer separated by an aquitard. The unconfined aquifer, confined aquifer, and aquitard are all water-saturated and are therefore hydraulically connected (Cohen and Cherry, 2020).

5.1 Hydraulics of Flow in Confined Aquifers

In the preceding sections, the various experimental setups used to illustrate concepts of hydraulic head and flow are similar to those in a confined aquifer, because a confined aquifer is bounded by layers of low hydraulic conductivity relative to the aquifer. When the confining layers have a much lower hydraulic conductivity than the aquifer, the confining layers act in a manner similar to no-flow boundaries, because they restrict nearly all flow across the aquitard, which was the case for all of the experimental scenarios presented earlier. Under most natural conditions, some water can migrate across a water-saturated aquitard in accordance with Darcy’s law if there is a hydraulic gradient across the aquitard.

Fundamental to flow in confined aquifers is the concept of the potentiometric surface. **Figure 20** provides insight into why the phrase is applicable to confined conditions; the potentiometric surface is actually an imaginary surface (**Figure 20a**) that can be defined using equipotential contours viewed in the x-y plane (**Figure 20b**). We are already familiar with its representation in cross section (**Figure 20c**). The effects of aquitards on confined flow are presented in Section 5.3.

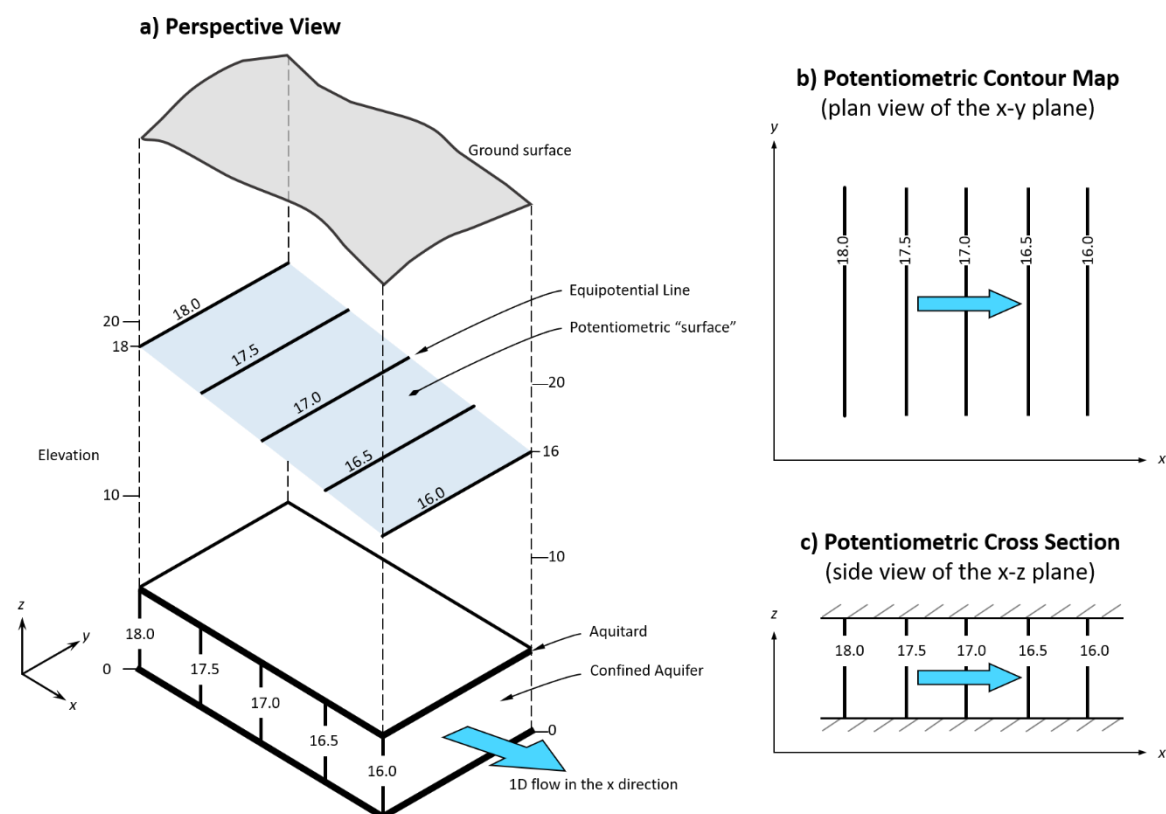
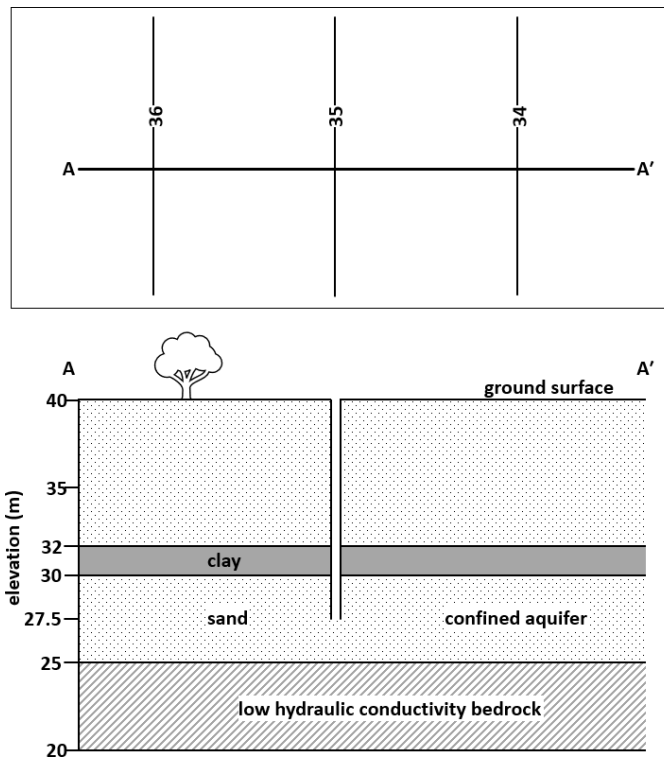

Figure 20 - Potentiometric contours for a confined aquifer shown in various views: a) perspective; b) plan; and c) cross section. In the plan view, the potentiometric surface can be represented using equipotential lines in a manner similar to elevation contour lines used to represent ground surface topography (Cohen and Cherry, 2020).

Example Problem 4

The figures for this problem show a potentiometric contour map of a confined aquifer and a cross section along transect A-A'. What is the depth of the water level in the well (relative to ground surface)? Explain.

- a) 3 m
- b) 5 m
- c) 7.5 m
- d) 10 m



[Click here for solution to Example Problem 4](#) ↓

5.2 Hydraulics of Flow in Unconfined Aquifers

Groundwater flow in unconfined aquifers obey the same principles as flow in confined aquifers with an added element; the elevation of the top of the saturated zone defines a “water table”, which is the elevation of water that stands in a screened well that is just deep enough to encounter water. For example, the hydraulic head of the water table intersected by the shallow well shown in **Figure 21** is 100 m. In addition, consistent with our previous discussions, an equipotential contour connects points of equal hydraulic head, which is measured using wells (field-scale piezometers). The water table is not an equipotential line; it has a variable head because it varies in elevation.

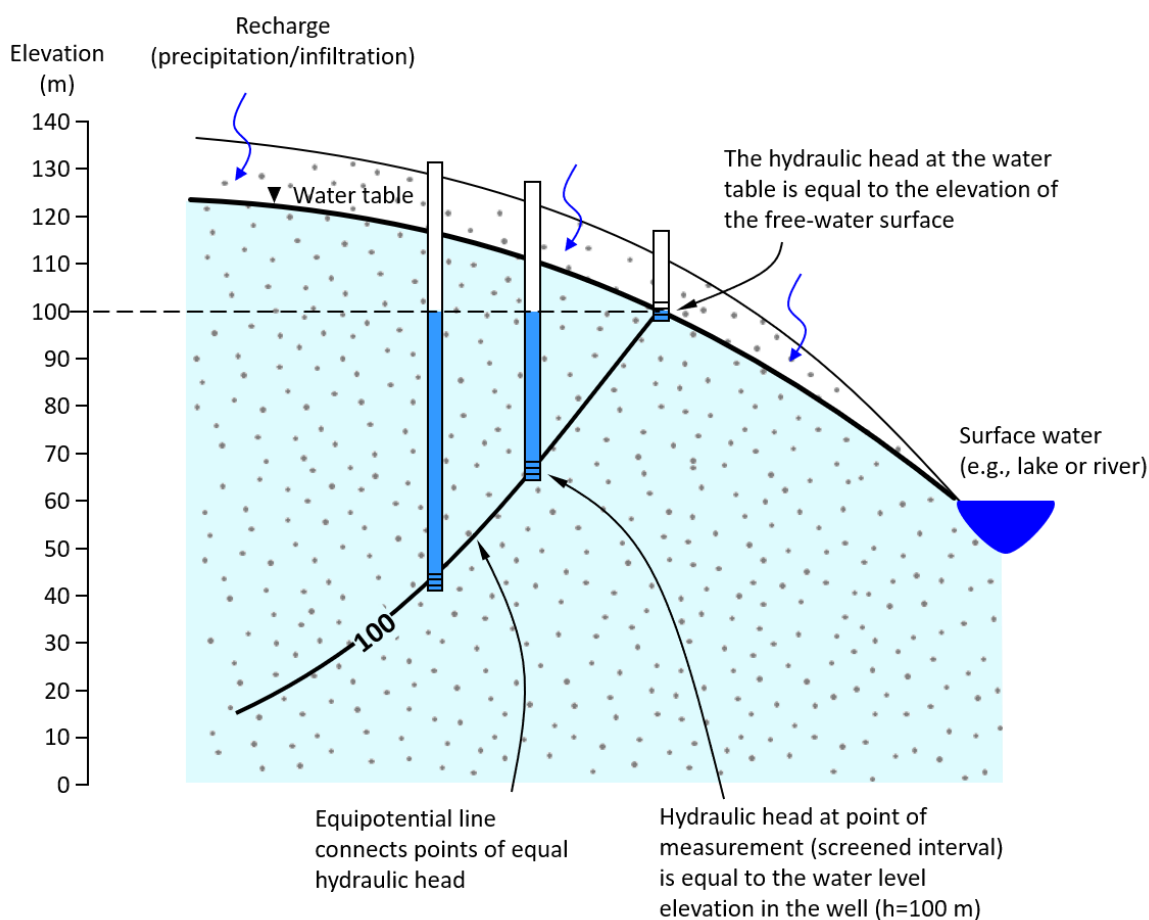

Figure 21 - Equipotential contours in an unconfined aquifer; the contour lines connect points of equal hydraulic head and extend to the water table of the same elevation (Cohen and Cherry, 2020).

Figure 22 shows that the water table can also be represented in map view. Each contour line represents a line of equal elevation of the water table. Note also that the water table gradient increases (steeper water table and more closely spaced contour lines) in the direction of flow because of convergent flow, which decreases the cross-sectional area of flow, as shown previously in **Figure 5**.

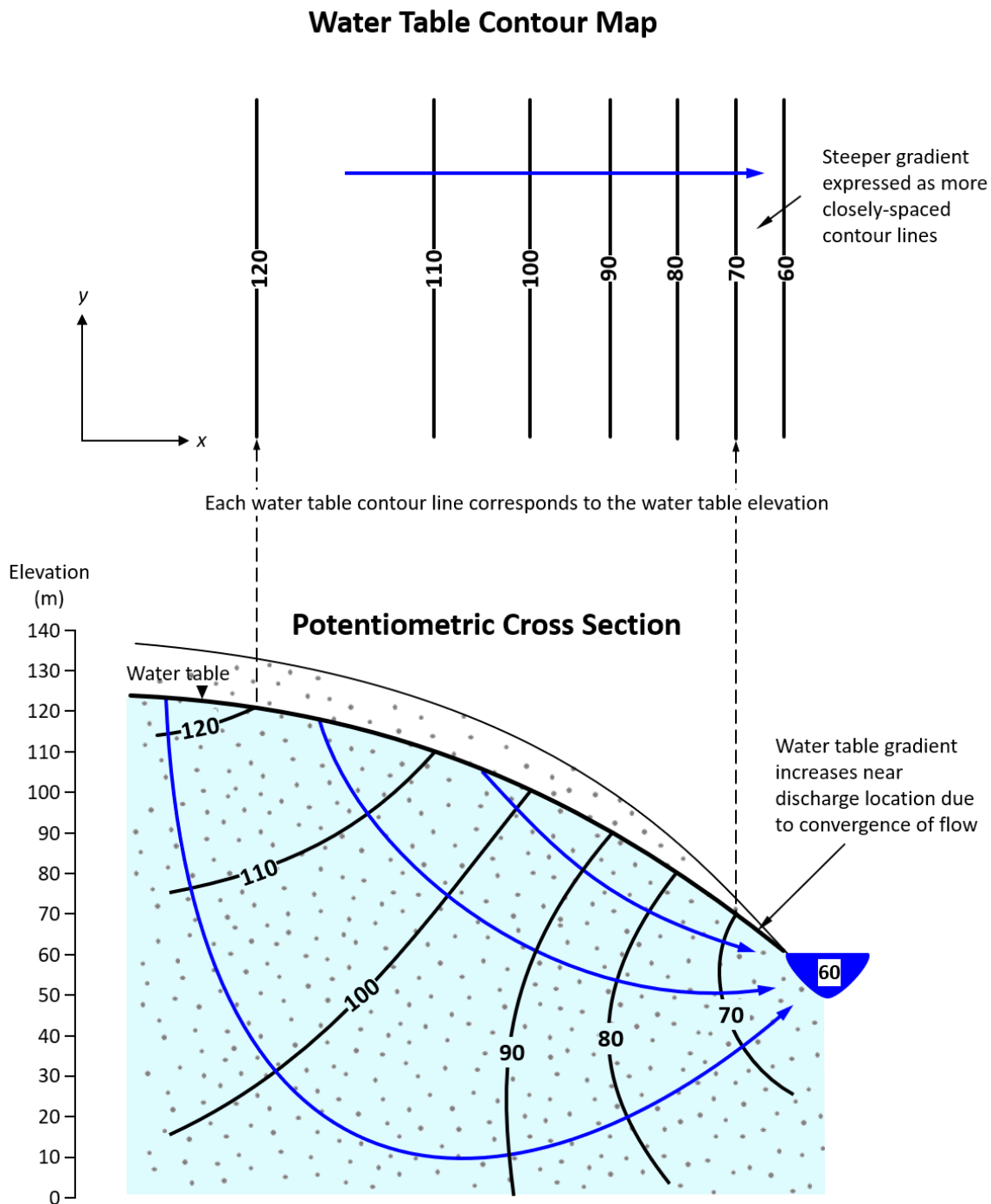
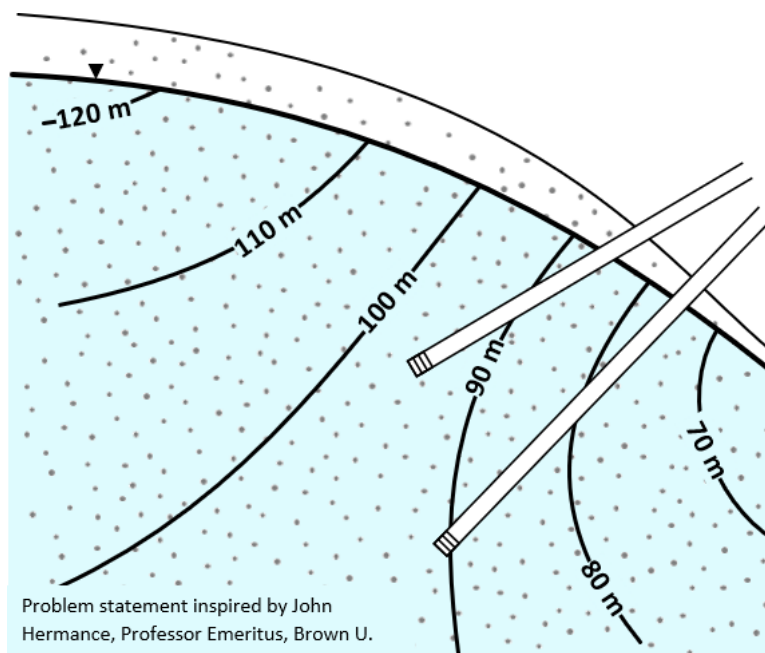

Figure 22 - Potentiometric cross section, groundwater flow direction (blue arrows), and water table contour map in an idealized unconfined aquifer. The contour map represents the topography of the water table and can be used to infer the general direction of flow. The flow geometry beneath the water table is defined by equipotential contours in cross section (Cohen and Cherry, 2020).

Example Problem 5

To what level (elevation) will water rise in the inclined wells?



[Click here for solution to Example Problem 5](#) ↴

Figure 23 shows the vertical head profile measured in nested wells. These data could also be measured in multilevel (multiport) wells, for example. Importantly, the figure shows that although vertical gradients are present, flow also has a horizontal component. That is, the presence of a vertical gradient does not necessarily indicate that flow is completely vertical, only that a component of flow is vertical.

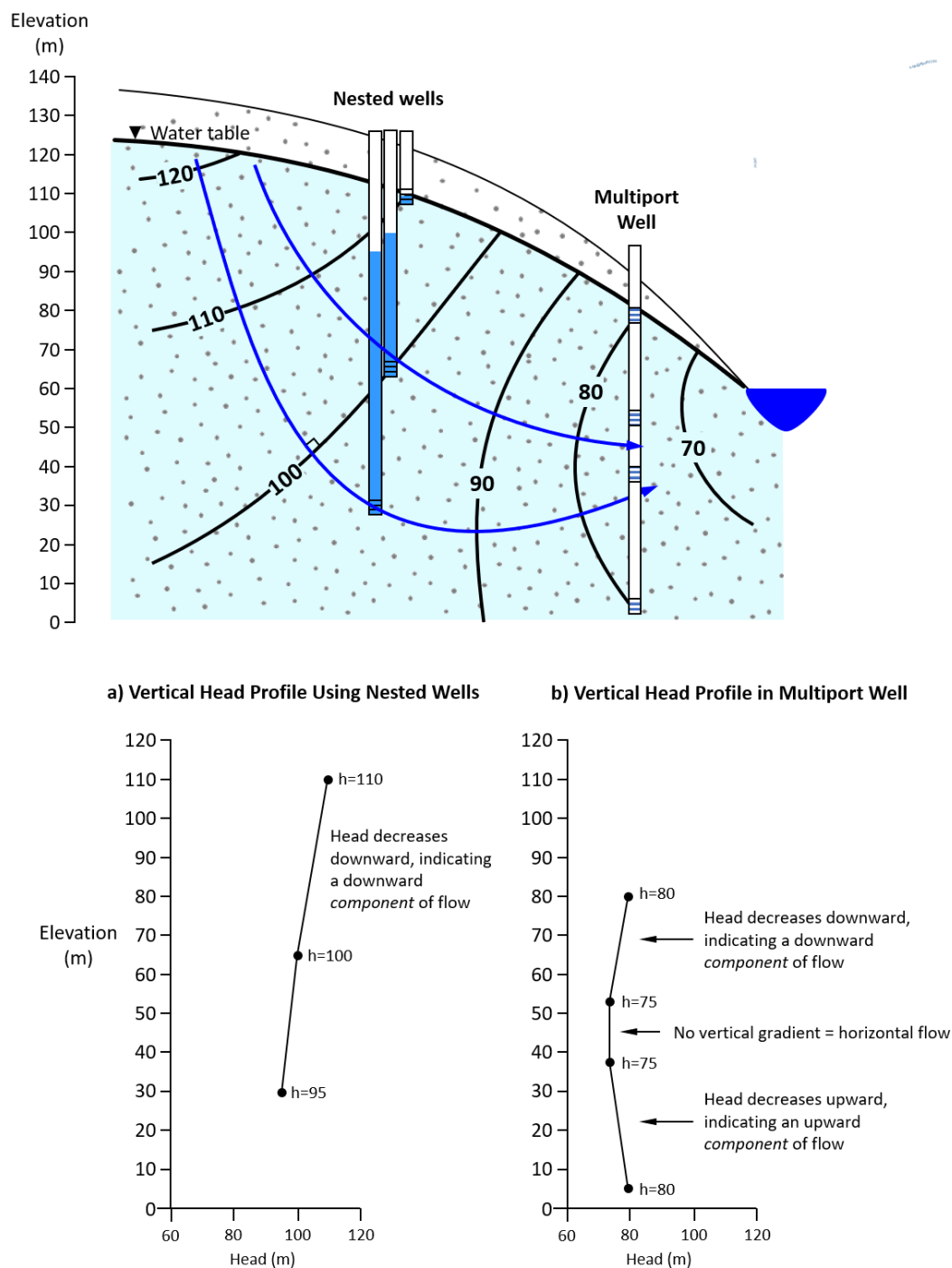

Figure 23 - Example of vertical head profiles in an idealized unconfined aquifer (Cohen and Cherry, 2020).

The potentiometric contours and flow geometry in the unconfined aquifer scenario shown in **Figure 23** are representative of a case in which a vertical no-flow boundary is present near the upgradient end of the system (left side). This boundary has the effect of causing significant vertical flow in that region (see **Figure 18** for an analogous experimental apparatus and contours). In many instances, a no-flow boundary may not be nearby, and flow in the area of interest is mainly horizontal as shown in **Figure 24**.

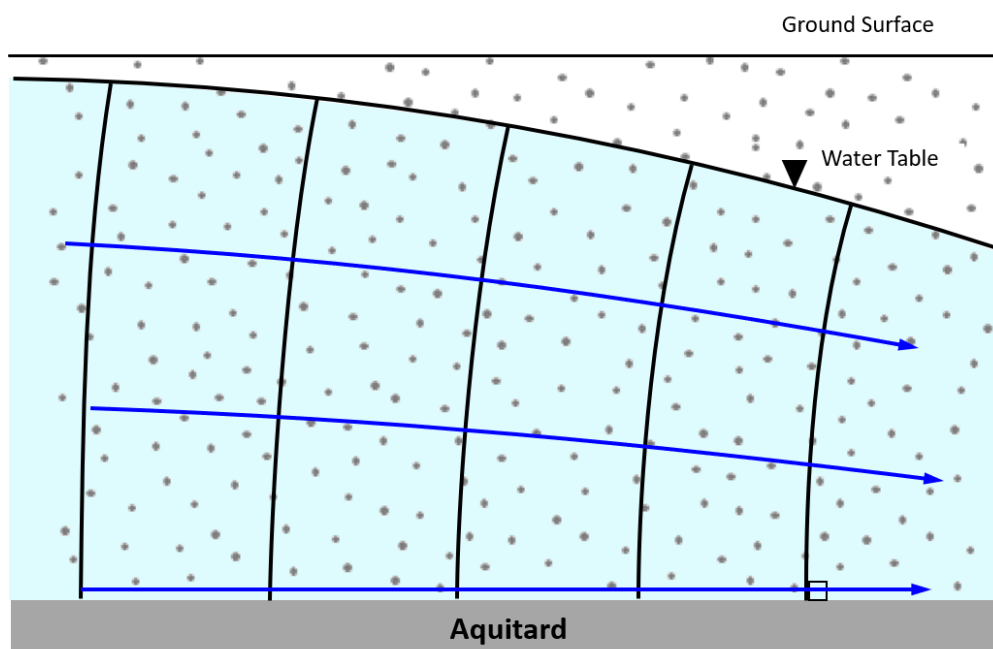

Figure 24 - Mainly horizontal flow in an unconfined aquifer. The potentiometric contours are orthogonal to the aquitard, which has a very low hydraulic conductivity (K) such that it behaves as a no-flow boundary (Cohen and Cherry, 2020).

In practice, horizontal flow in unconfined aquifers is often approximated as purely horizontal, especially when assessed on a sub-regional scale and away from boundary conditions, as shown in **Figure 25**.

Water table approximated as a planar surface with idealized horizontal flow for estimating horizontal flow direction in unconfined aquifers

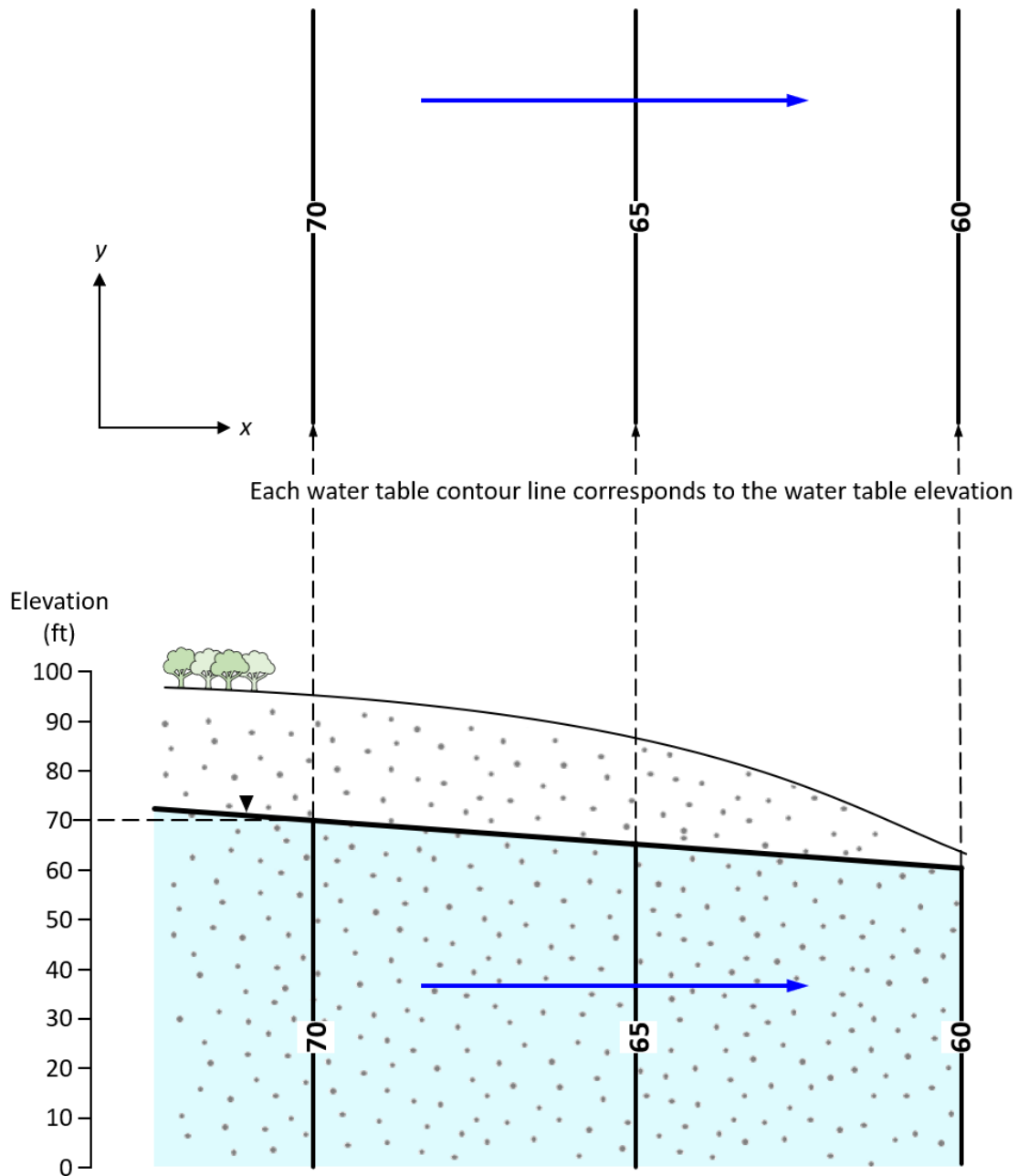
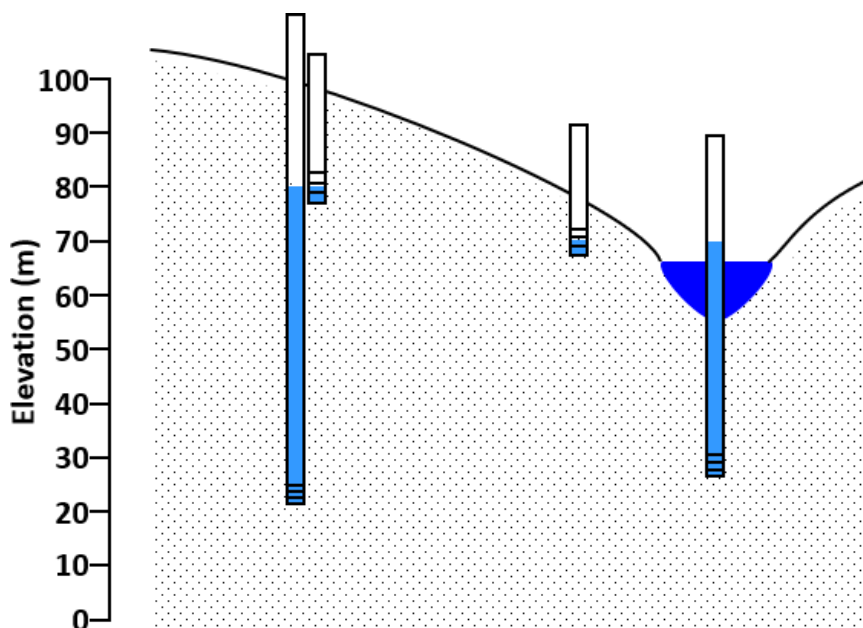

Figure 25 - Water table represented as a planar surface with predominantly horizontal flow throughout the cross section (Cohen and Cherry, 2020).

Example Problem 6

- Draw the water table.
- Draw the 70 m, 75 m, and 80 m equipotential contours and sketch several flow lines.



[Click here for solution to Example Problem 6](#) ↴

Example Problem 7

- A piezometer is inserted into an aquifer beneath sediment (low K) of a lake, and water rises to a stable level as shown below. A water table is present but not shown. Is water flowing upward or downward through the sediment? Explain.
- Draw a schematic representation of the vertical head profile, extending from the water level of the lake to the well screen.

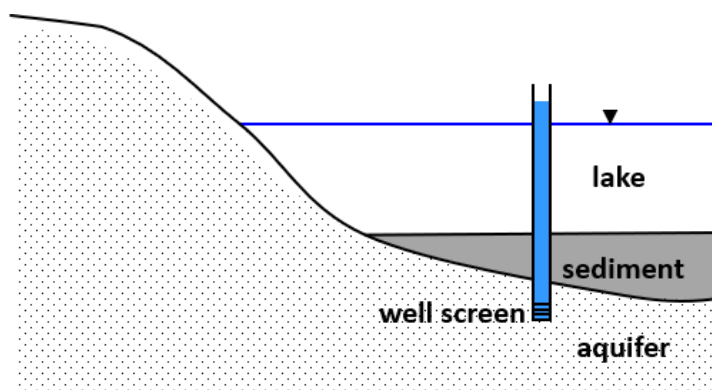

[Click here for solution to Example Problem 7](#) ↴

Example Problem 8

The figure below is a map view of a lake and shoreline. The water table elevation at Well A is 12 m. Assuming the water table is planar (an inclined plane), what is the expected water level elevation in Well B?

- a) 12 m
- b) 13 m
- c) 14 m
- d) A value between 12 m and 13 m

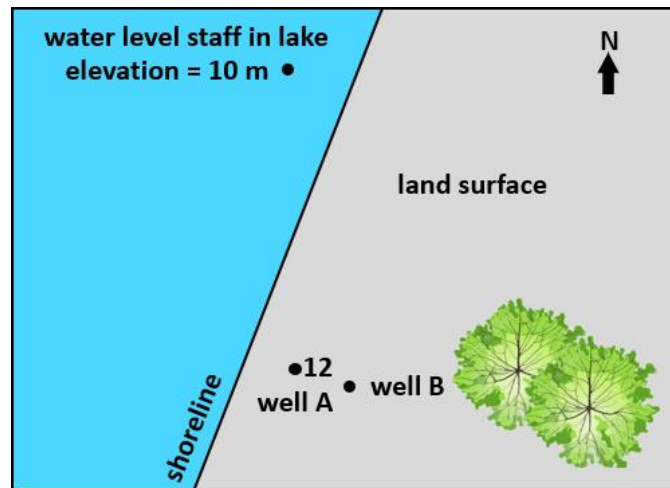

[Click here for solution to Example Problem 8](#) ↴

Example Problem 9

Estimate the water level in each well and determine if there is vertical flow through the clay aquitard.

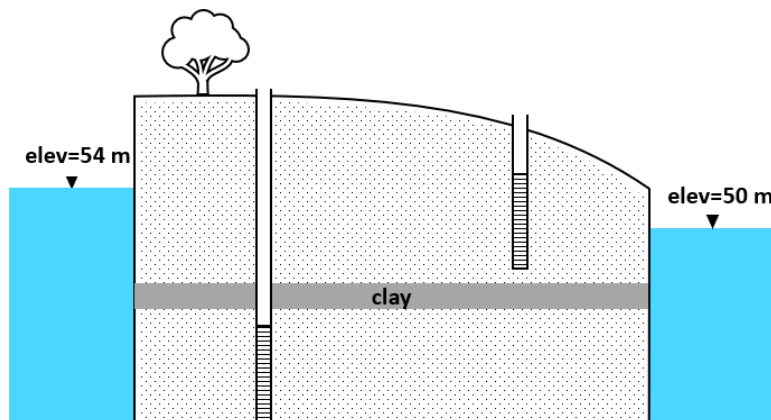

[Click here for solution to Example Problem 9](#) ↴

5.3 Aquifers and Aquitards

The flow and associated hydraulic gradient scenarios shown in the previous figures are also present in aquifers separated by an aquitard. As shown in **Figure 26**, the horizontal gradient in the unconfined aquifer and confined aquifer are defined by the water table and potentiometric surface, respectively. In **Figure 26**, head decreases towards the right in both aquifers. Accordingly, groundwater flows towards the right. However, there is a difference in hydraulic head above and below the aquitard, as shown by the labeled head values on the cross section. These values are based on the water table and potentiometric surface. **Figure 26a** illustrates the water table and potentiometric surface and shows the hydraulic heads at the two ports in the graph on the right. **Figure 26b** shows the same scenario using a multiport well with many sample points.

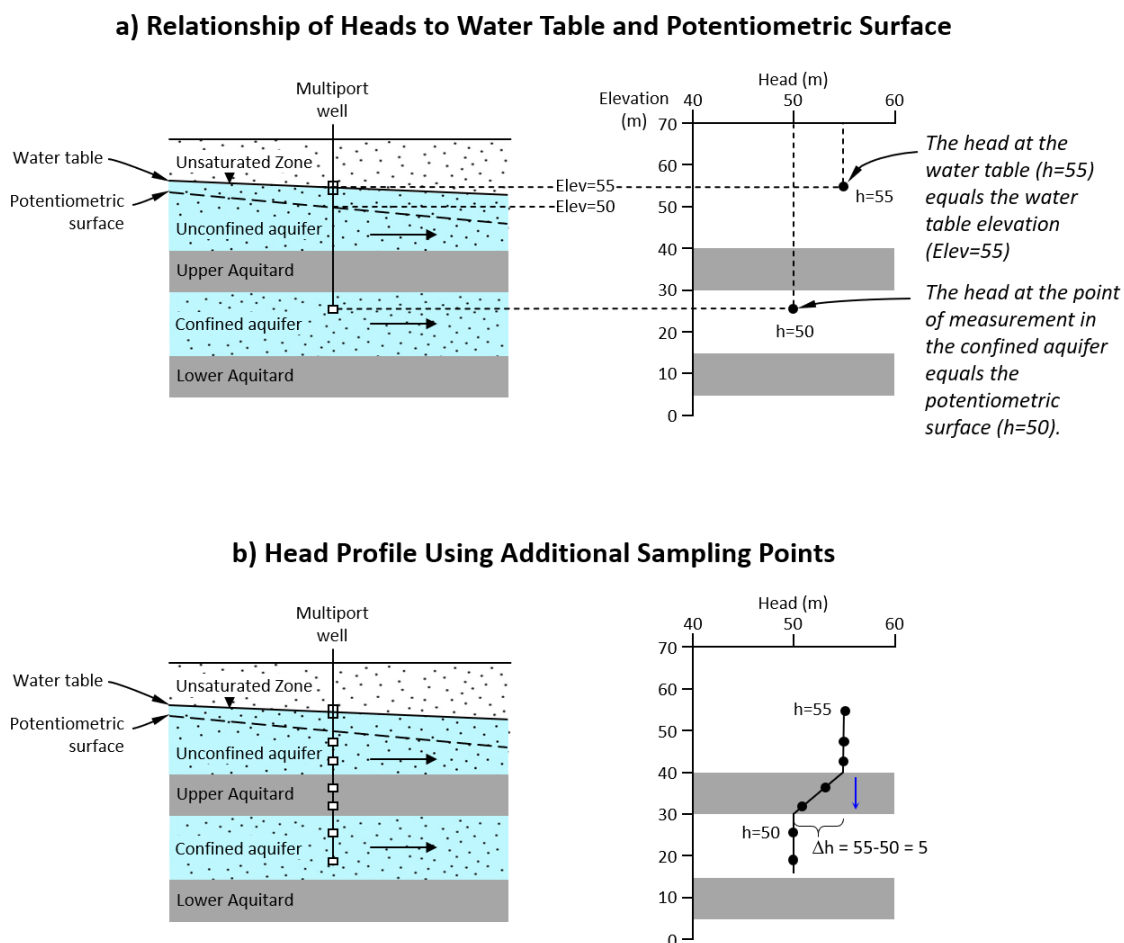

Figure 26 - Example of horizontal flow and associated vertical head profile in: a) an unconfined and b) a confined aquifer, and the associated vertical gradient in an aquitard (Cohen and Cherry, 2020).

The chart on the right side of **Figure 26b** shows a portion of the corresponding vertical hydraulic gradient profile. There is a distinct change in hydraulic head across the aquitard, which is indicative of a zone of lower hydraulic conductivity. The vertical hydraulic head gradient indicates that, although most of the flow in the unconfined and

confined aquifers is horizontal, there is a fraction (albeit relatively small) that flows downward through the aquitard (from higher head to lower head). As mentioned earlier, it is important to note that the vertical gradient does not necessarily mean that the flow through the aquitard is vertical. Rather, it indicates that there is a vertical component of flow.

If the presence of a lower- K interval (e.g., the upper aquitard) was not known, the hydraulic heads shown in **Figure 26a** could be interpreted as an indication of downward flow throughout the entire saturated zone, because the head is higher ($h=55$ m) in the shallower zone than in the deeper zone ($h=50$ m). This exemplifies the need to account for the known or potential geologic features and properties of the subsurface when interpreting head data.

Figure 27 shows that the direction of flow in the aquitard is dependent on the relative elevations of the water table and potentiometric surface.

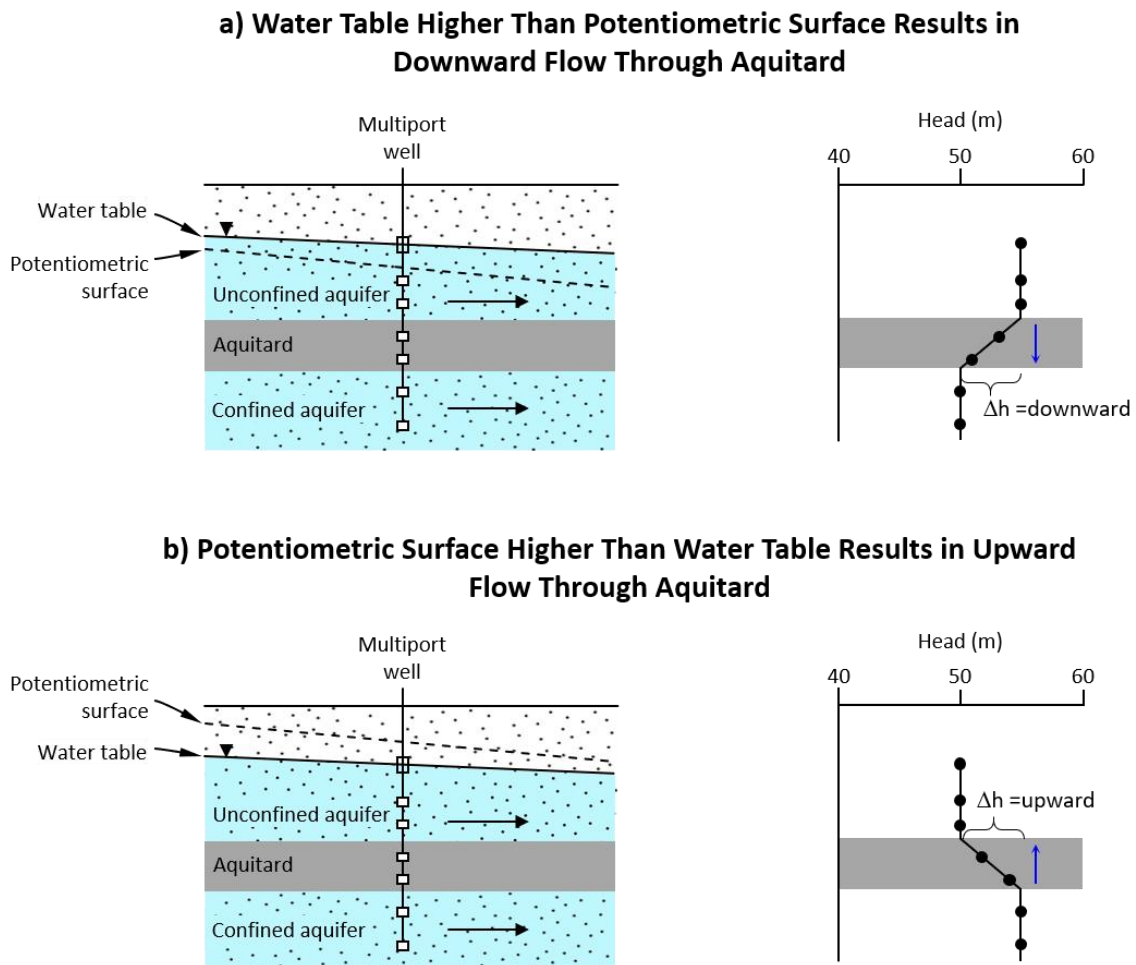

Figure 27 - Head profile across aquitards resulting in: a) downward and b) upward flow (Cohen and Cherry, 2020).

As noted previously, an aquitard is a semi-pervious formation that restricts flow between the overlying and/or underlying aquifers. It may be composed of very low

hydraulic conductivity soil or rock that restricts nearly all groundwater flow between the aquifers. In the vicinity of a recharge or discharge area, the groundwater in both unconfined and confined aquifers can have a significant vertical flow component even in the presence of an aquitard.

In some cases, the hydraulic conductivity of the aquitard is less restrictive, and some groundwater may flow between the overlying and underlying aquifers. Such a formation may be referred to as a *leaky aquitard*. In either case, groundwater is present and fully saturates the aquitard, and therefore some hydraulic connection between the aquifers exists. Accordingly, there is a hydraulic gradient in the aquitard, as shown in **Figure 28**.

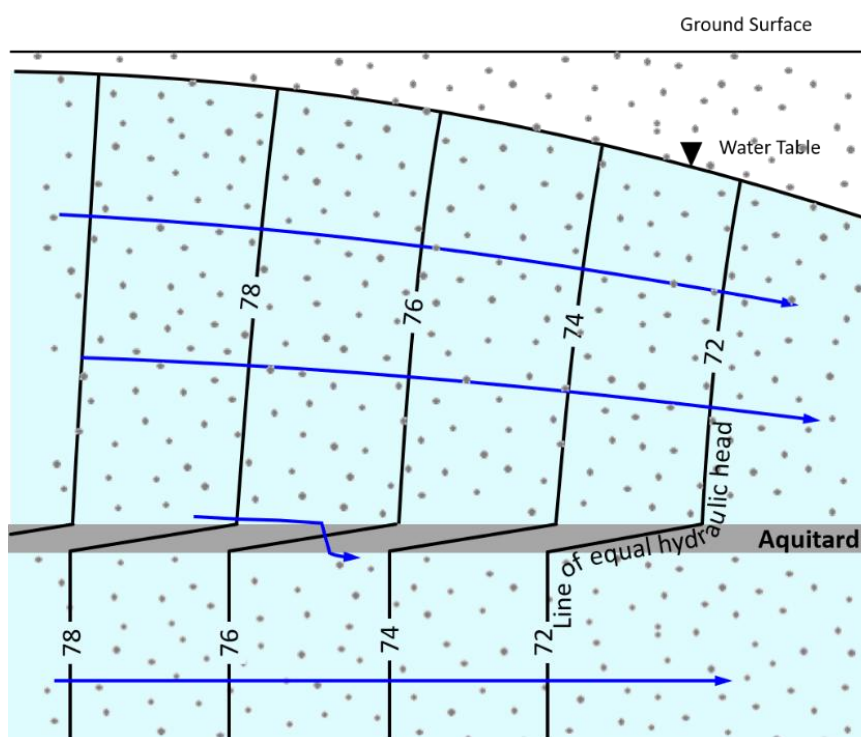
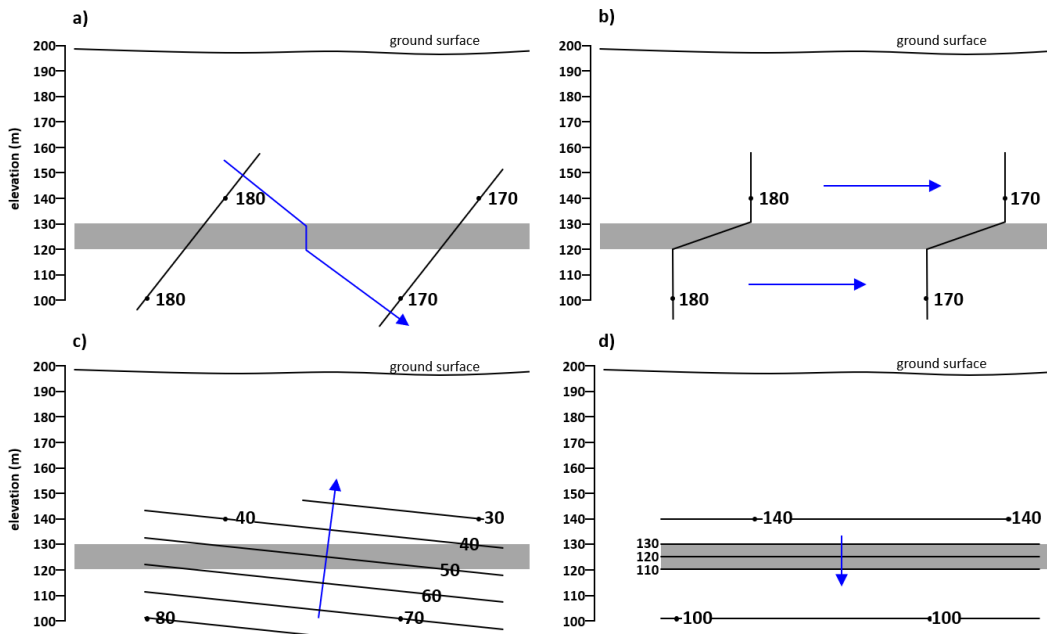
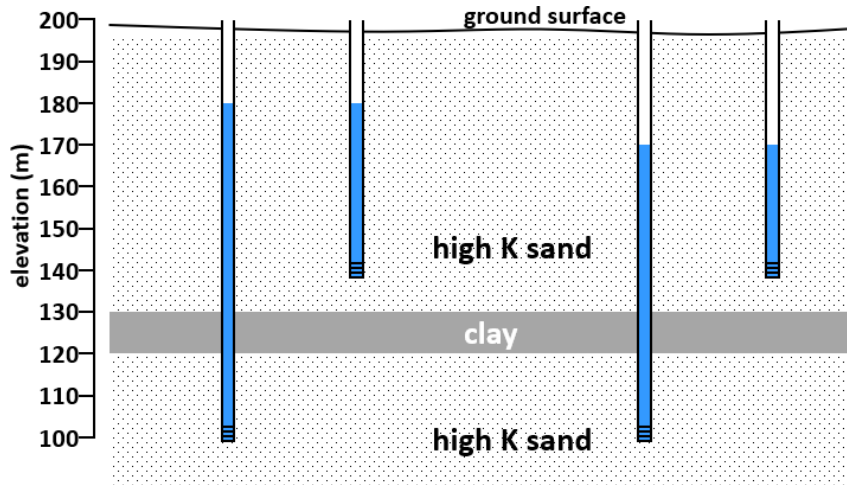

Figure 28 - Potentiometric contour lines in an unconfined and confined aquifer separated by an aquitard (Cohen and Cherry, 2020).

Example Problem 10

Based on the water level data shown, which schematic below best represents the equipotential lines and flow direction?



[Click here for solution to Example Problem 10](#) ↴

Example Problem 11

- Draw potentiometric contours in the lower sand unit at 1 m intervals.
- Draw the potentiometric surface.
- What is the direction of groundwater flow through the upper clay unit?
- Sketch the expected vertical hydraulic head profile in the vicinity of Well 2.

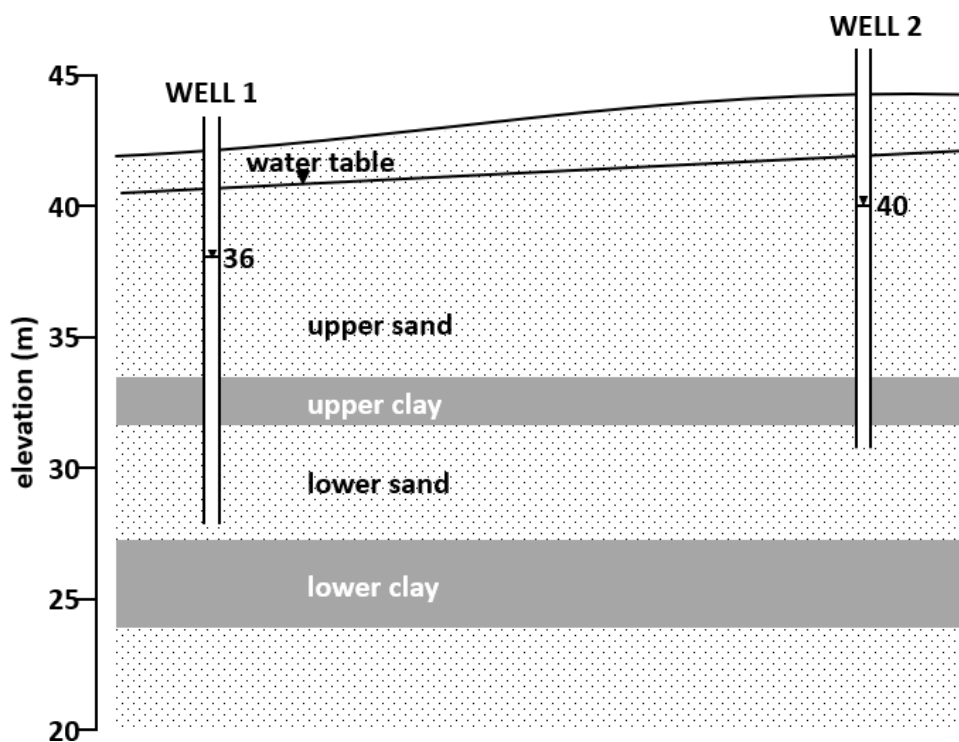

[Click here for solution to Example Problem 11](#) ↴

Example Problem 12

1. Draw potentiometric contours in the lower sand unit at 1 m intervals.
2. Draw the potentiometric surface.
3. What is the direction of groundwater flow through the upper clay unit?
4. Sketch the expected vertical hydraulic head profile in the vicinity of well 2.

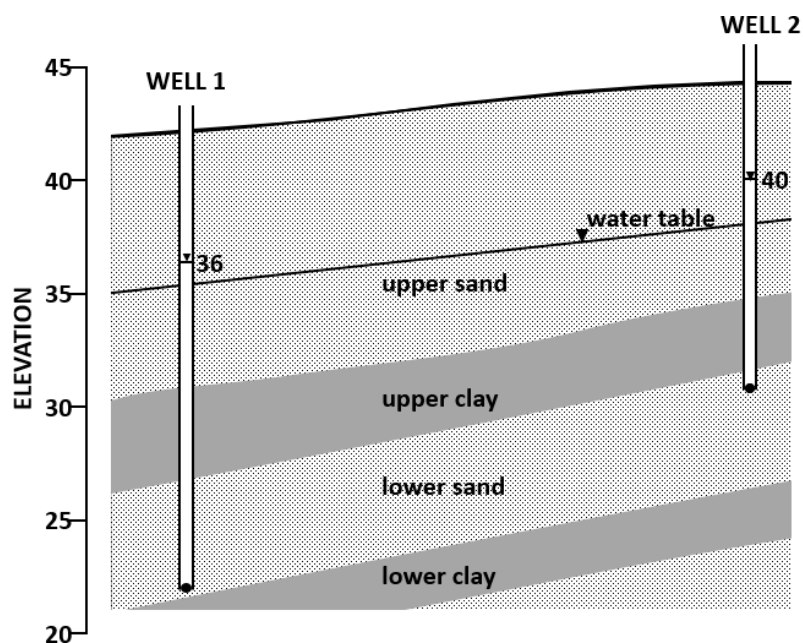

[Click here for solution to Example Problem 12](#) ↴

6 Summary

The objective of this book is to introduce the most basic and essential concepts in groundwater science. In particular, the fundamentals of Darcy's law under steady, saturated, and isotropic conditions. Concepts of hydraulic head, hydraulic gradient, potentiometric contours, and flow of water on a laboratory scale that are analogs to flow in aquifers and aquitards is presented, along with representation of these concepts at the field scale. The material is presented in a conceptual manner by explaining phenomena with minimal mathematical detail and numerous sketches with imbedded narrative that highlight key features and phenomena. Figure 29 summarizes some of the key elements presented in this book. References to a limited set figures that present more detail are indicated in Figure 29. It is most useful to read the book from start to finish and study all figures, because they are presented in an iterative manner and rely on previous figures to provide deeper understanding of the fundamentals and their manifestation in groundwater systems.

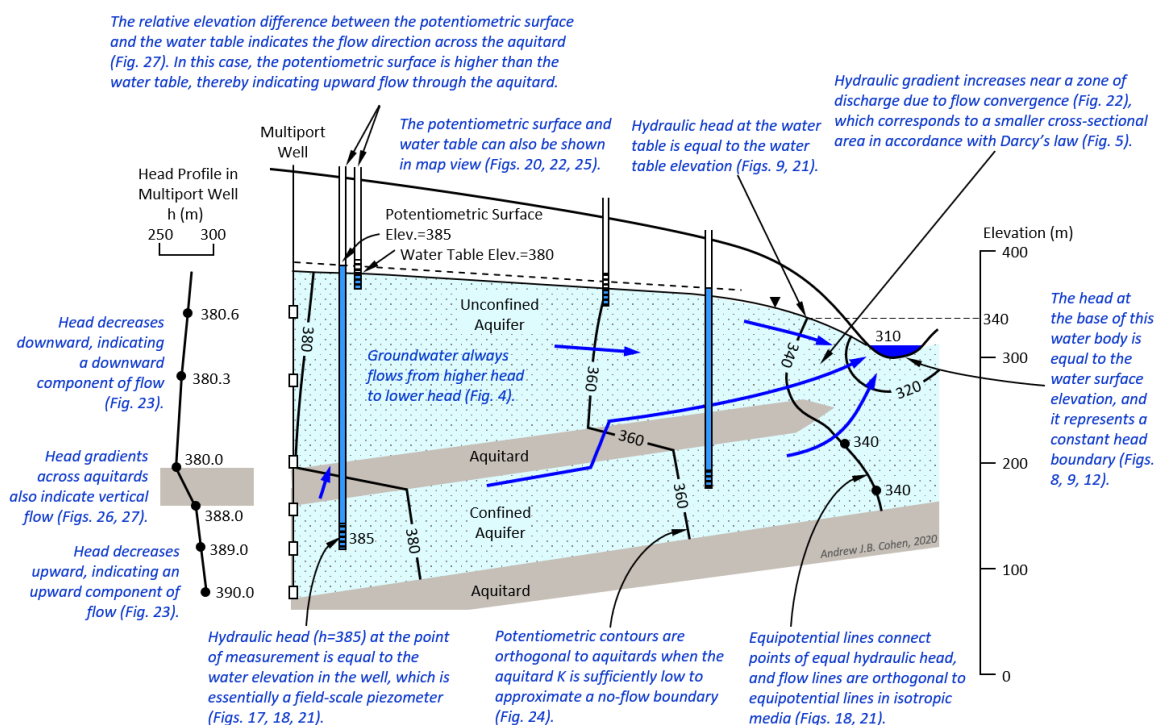

Figure 29 - Summary of concepts presented in this book (Cohen and Cherry, 2020).

7 Solutions to Example Problems

Problem 1 Solution

Question: Sketch the hydraulic head gradient along the length of the cylinders below.

Solution:

- Flow is from right to left. Therefore, the head decreases to the left.
- Gradient must be steeper in Section A than in Section B, because the cross-sectional area of Section A is less than in Section B, while both sections have the same K.
- Gradient in Section C is steeper than in Section A, because K in Section C is less than in Section A, while both sections have the same area.
- Gradient in Section C is the steepest, because it has the lowest K while also having a small cross-sectional area.

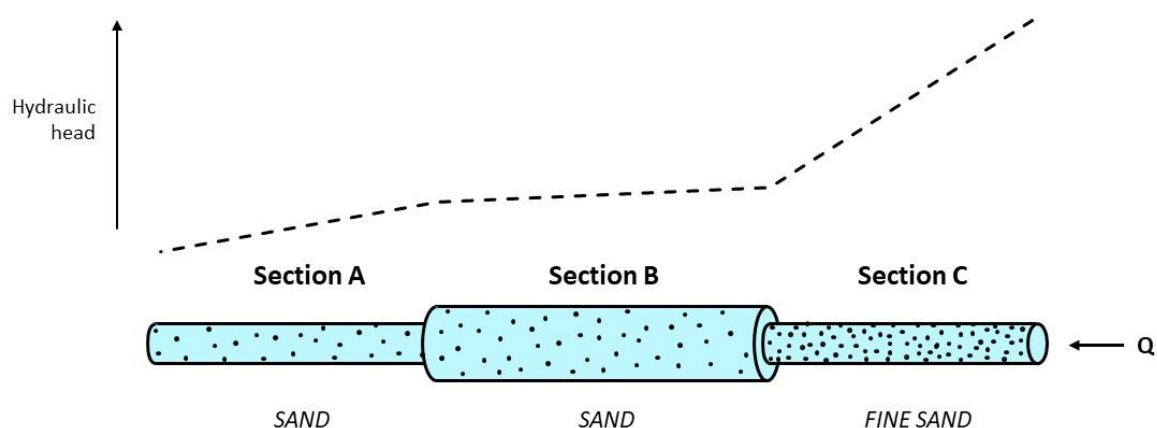

[Return to Example Problem 1](#) ↑

Problem 2 Solution

Question: What is the hydraulic head at the point in the column shown below?

- a) 1 ft
- b) 2 ft
- c) 3 ft
- d) 4 ft
- e) 5 ft

Solution: The correct answer is 5 ft, because the hydraulic head everywhere in the static water column is equal to the elevation of the water surface. The head is not 1 ft, because hydraulic head is not equal to the height above the base of the water column. The head is not 2 ft, because hydraulic head in the water column is not equal to the elevation of the point of measurement. The hydraulic head is not 3 ft, because hydraulic head is not equal to the height of the water column above the point of measurement. The hydraulic head is not 4 ft, because hydraulic head does not represent the total height of the water column above the point of measurement.

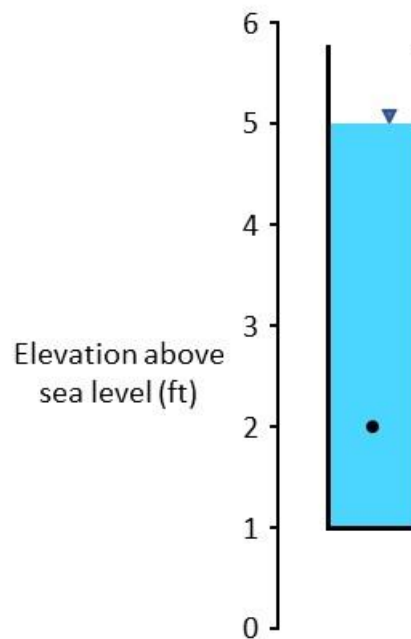

[Return to Example Problem 2 ↑](#)

Problem 3 Solution

Questions:

- Draw equipotential lines in the sand at 1 ft intervals.
- To what level will water rise in the hypothetical piezometer?

Solutions:

- The constant head values at the top and bottom of the sand column are equal to the water level elevation of the column of water that bounds each end of the porous medium. Flow must be vertical in the sand column given the geometry of the cylinder, and the potentiometric lines must be horizontal (potentiometric contours are perpendicular to the direction of flow and perpendicular to no-flow boundaries). The head gradient is specified by the spacing between contour lines; in this case, they must be equally spaced because the medium is homogeneous.
- The water level in a piezometer is equal to the hydraulic head at the point of measurement, which in this case is the open end of the piezometer in the sand. Therefore, the water level in the hypothetical piezometer is 14 ft.

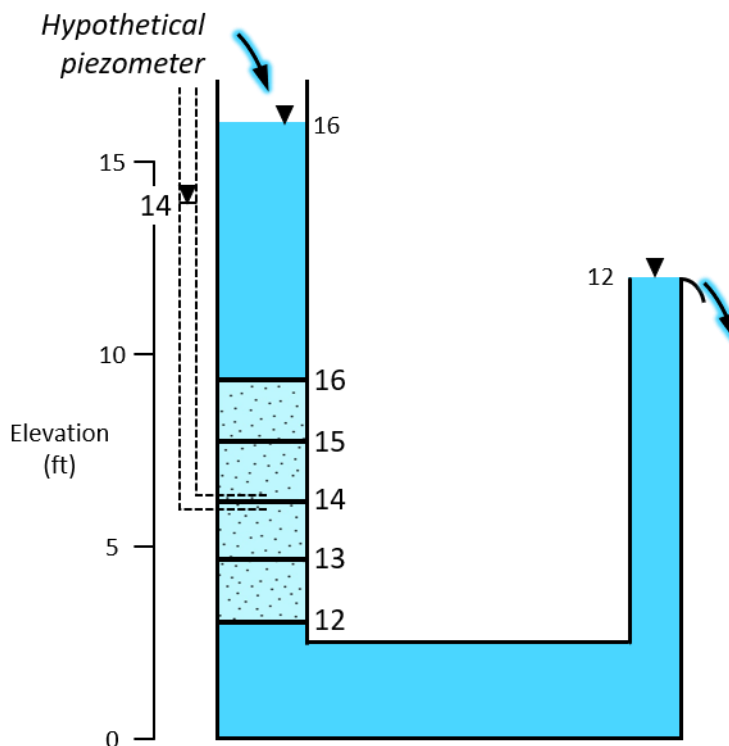

[Return to Example Problem 3](#) ↗

Problem 4 Solution

Question: The figures below show a potentiometric contour map of a confined aquifer and a cross section along transect A-A'. What is the depth of the water level in the well shown (relative to ground surface)? Explain.

- a) 3 m
- b) 5 m
- c) 7.5 m
- d) 10 m

Solution: The correct answer is 5 m deep, because the hydraulic head at the position of the well is 35 m (as indicated by the potentiometric contour map). Since water level in a well is equal to hydraulic head, the water level elevation in the well must be 35 m. Since the groundwater surface elevation is 40 m, the depth to water must be 5 m (40-35).

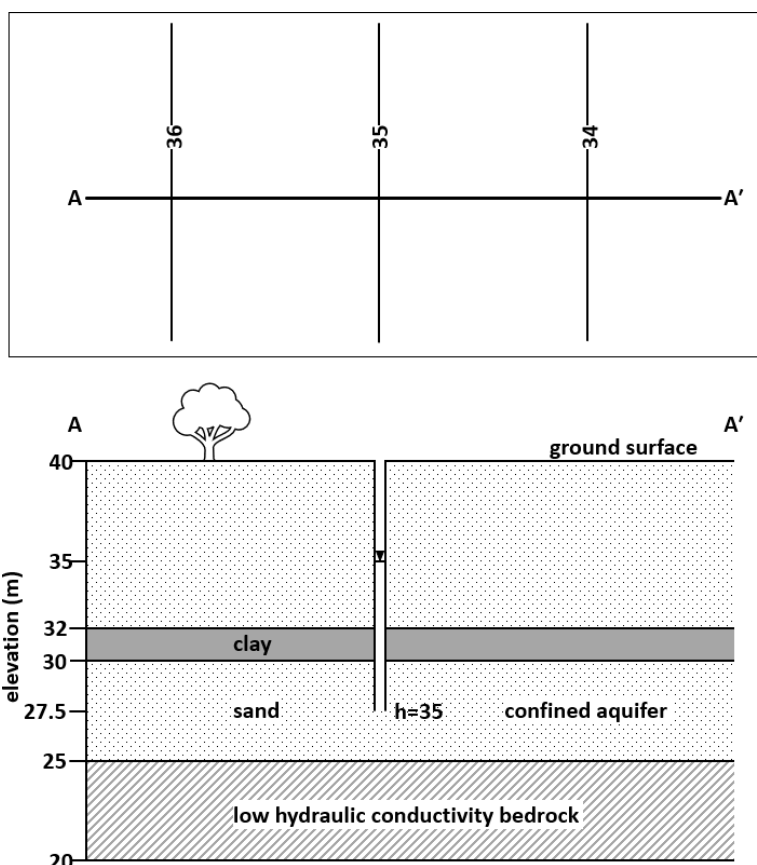

[Return to Example Problem 4](#) ↗

Problem 5 Solution

Question: What is the elevation of the water level surface in the inclined wells?

Solution: The water level is equal to the hydraulic head at the point of measurement (the screen interval), which is indicated by the potentiometric contour line. The orientation of the piezometer is of no consequence.

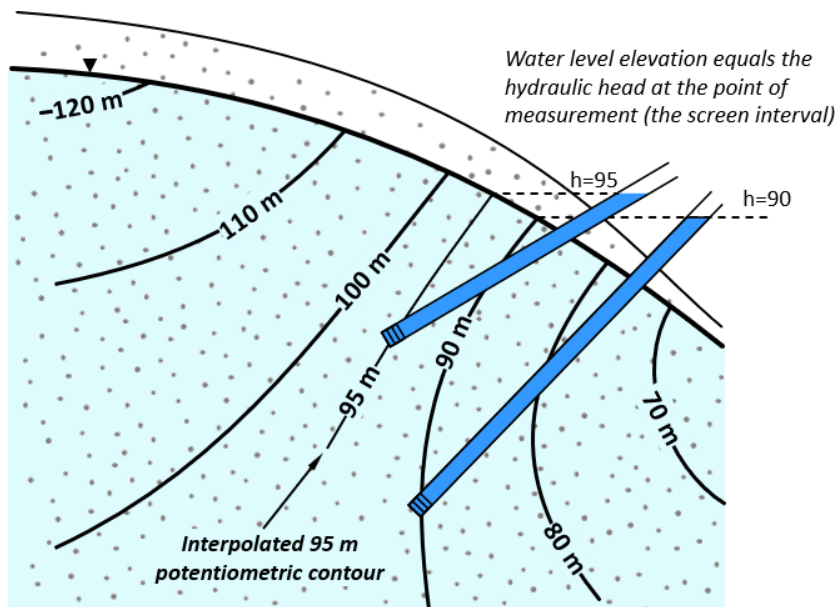

[Return to Example Problem 5](#) ↑

Problem 6 Solution

Instructions: Draw the water table and draw the 80 m and 70 m equipotential contours. Estimate the flow direction.

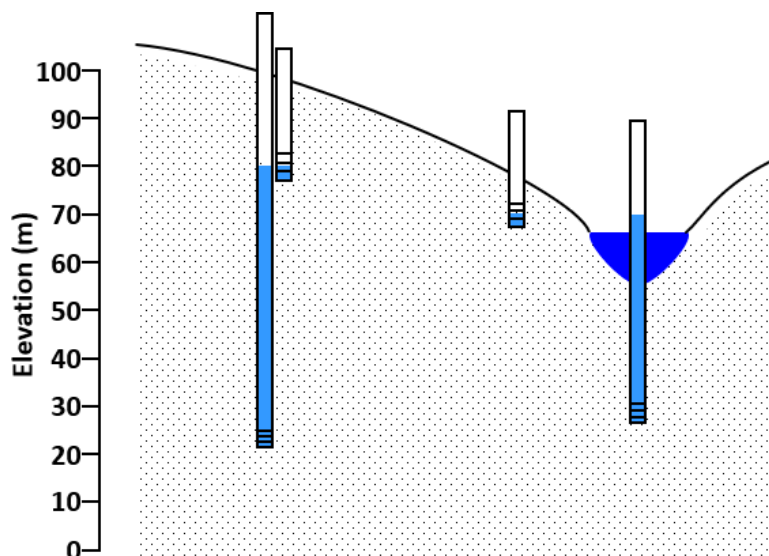

Solution Step 1: Recognize that the water level in the shallow wells are in the screened interval. Therefore, these water levels define a water table of an unconfined aquifer. Accordingly, the water table can be interpolated based on these data and also considering the elevation of the nearby water body.

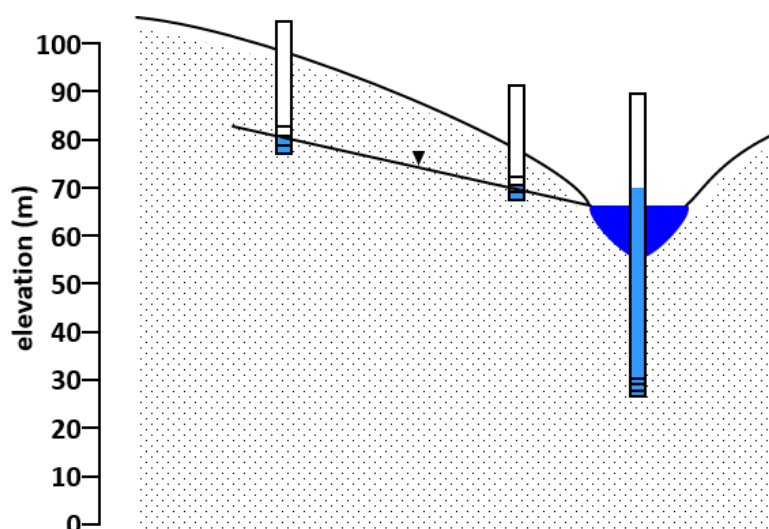

Solution Step 2: Define the hydraulic head at each measurement location, which includes the water table elevations and the water elevation in the wells screened at depth; the head is based on the points of measurement (the screen interval) and the corresponding water level elevations.

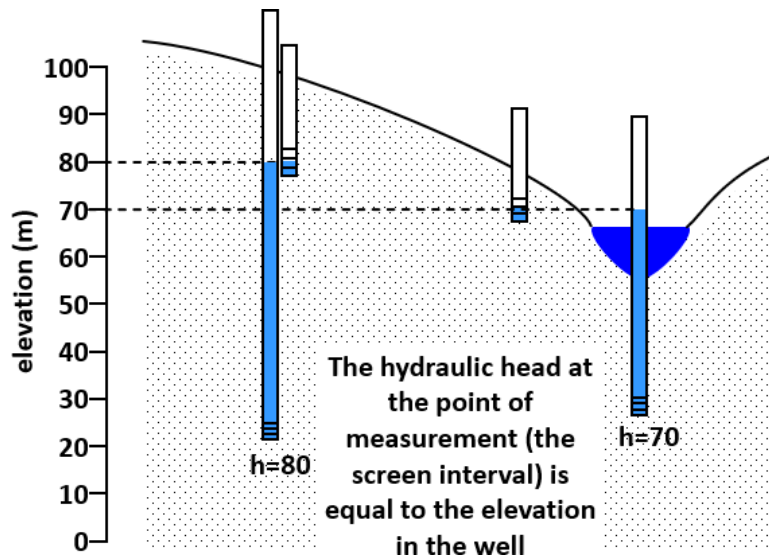

Solution Step 3: Using the resulting hydraulic head distribution, connect points of equal hydraulic head and/or approximate the location of equipotential contours by interpolating between values. Furthermore, consider the expected flow geometry given site features. In this case, we expect some convergence of flow towards the surface water body, so equipotential lines are curved rather than connected with a straight line. Draw flow lines perpendicular to the equipotential lines.

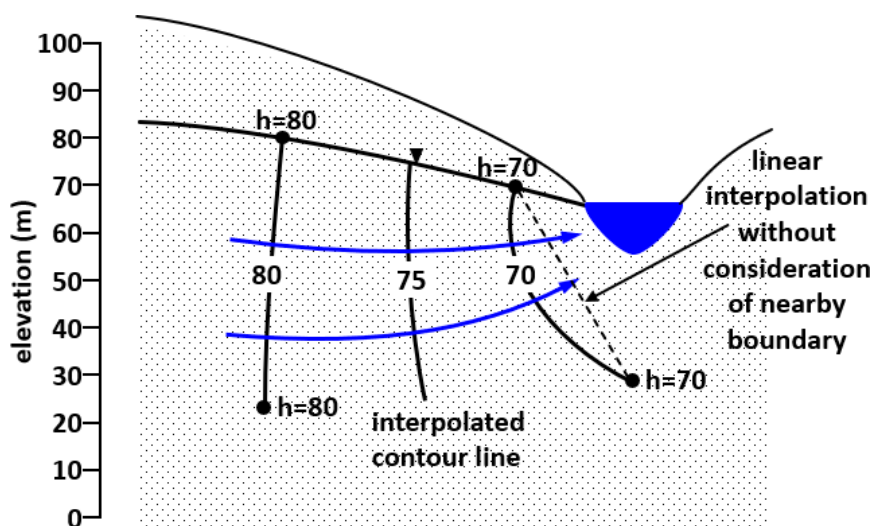

[Return to Example Problem 6](#) ↗

Problem 7 Solution

Questions:

- A piezometer is inserted into an aquifer beneath sediment (low K) of a lake, and water rises to a stable level as shown below. A water table is present but not shown. Is water flowing upward or downward through the sediment? Explain.
- Draw a schematic representation of the vertical head profile, extending from the water level of the lake to the well screen.

Solution a) The hydraulic head at the point of measurement (the screen interval) in the piezometer is equal to the elevation of the water level in the piezometer. The hydraulic head at all depths in the lake water is equal to the elevation of the lake surface. Therefore, the head below the sediment is higher than above the sediment, so flow moves upward through the sediment, because water moves from higher head to lower head.

Solution b) The vertical head profile shows the constant head in the lake and the upward gradient in the sediment. The head gradient also has an upward component in the aquifer, but the hydraulic conductivity is higher, so the gradient is not as large (it is less steep).

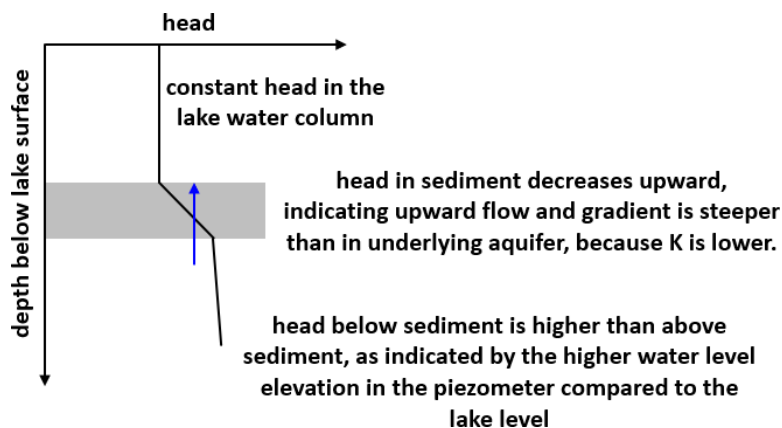

[Return to Example Problem 7](#) ↑

Problem 8 Solution

Question: The figure shows a map view of a lake and shoreline. The water table elevation at Well A is 12 m. Assuming the water table is planar (an inclined plane), what is the expected water level elevation in Well B?

- a) 12
- b) 13
- c) 14
- d) A value between 12 and 13

Solution: The water level in the lake is horizontal. Therefore, the head is the same everywhere in the lake, including along the length of the lake-shoreline interface. Since flow is orthogonal to equipotential lines and the water table is assumed planar, the contour interval of 2 m is extrapolated upgradient, thereby resulting in a water level of 14 m at Well B.

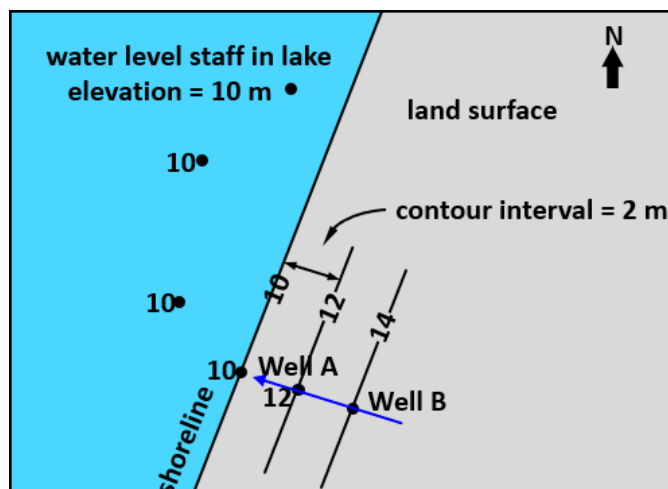

[Return to Example Problem 8](#) ↗

Problem 9 Solution

Question: Estimate the water level in each well and determine if there is vertical flow across the clay aquitard.

Solution:

Step 1: As an approximation, assume the water table is linear. By linear interpolation, the water level in the center is 52 m. The well on the right is half the distance from the right side to the middle, so the water level is 51 m. Similarly, the water table elevation at the location of the well on the left side is 53 m.

Step 2: The horizontal confined aquifer beneath the clay is bounded on both sides by constant head boundaries, the values of which correspond to the water level elevation in each water body (see Figures 12 and 17 for analogous scenarios). Flow is horizontal based on the geometry of the confined aquifer and the position of the boundaries (on either end).

Step 3: The medium is homogeneous, so the gradient is constant, meaning that the spacing between the equipotential lines is constant. The spacing between the lines and their values are determined by linear interpolation.

Step 4: The well on the left side is screened in the confined aquifer where the head is 53 m (as indicated by the equipotential line). At this same location, the water table elevation is also 53 m. We simplified by assuming a linear decline of the water table even though we know there will be a steeper gradient at the right side due to the decreasing flow area perpendicular to flow (as illustrated in Figure 22). Because we are assuming a linear gradient in both the confined and unconfined aquifer the head at each location will be the same above and below the clay. As a result, there is no vertical gradient and so, no vertical flow across the clay.

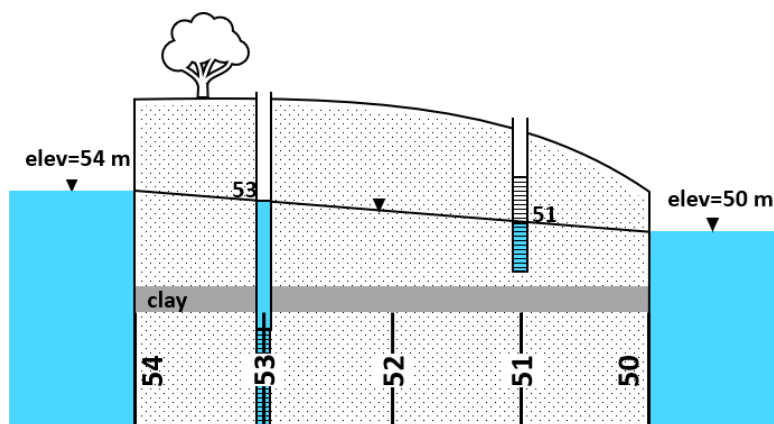

[Return to Example Problem 9](#) ↗

Problem 10 Solution

Question: Based on the water level data shown, which schematic below best represents the equipotential lines and flow direction?

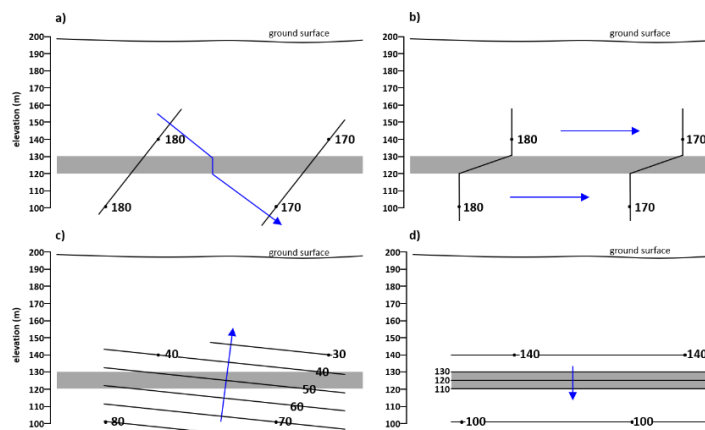
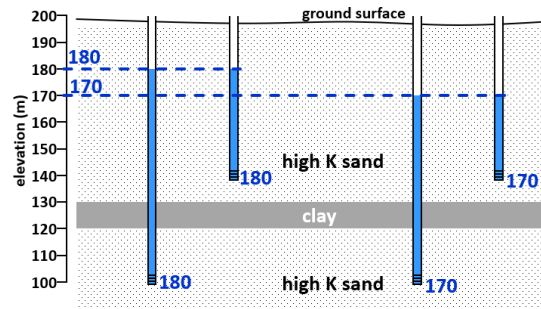

Solution: The correct answer is choice “b”: The head at each screened interval is equal to the elevation of the water level in each well. Based on the head data in the sand zones, hydraulic head decreases toward the right, and vertical flow will be restricted due to the aquitard. Accordingly, flow in the sand zones is mainly horizontal, and the potentiometric contours are nearly vertical because flow is orthogonal to potentiometric contours in isotropic media.

Choice “a” is NOT the correct answer. The head value plotted at each point is correct because it is the elevation of the water in the well. However, this cannot be the correct answer, because the equipotential line does not have an inflection at the top and bottom of the low-K interval (see Figure 28).

Choice “c” CANNOT be the correct answer, because the head values plotted at the points of measurement do not represent hydraulic head. Instead, they represent the height of the water column in each well.

Choice “d” CANNOT be the correct answer, because the values plotted at the points of measurement do not represent hydraulic head; instead, they are the elevations of the points of measurement.

[Return to Example Problem 10](#) ↑

Problem 11 Solution

Instructions/questions:

- Draw potentiometric contours in the lower sand unit at 1 m intervals.
- Draw the potentiometric surface of the lower sand unit.
- What is the direction of groundwater flow through the upper clay unit? and
- Sketch the expected vertical head profile in the vicinity of Well 2.

Solution 11a)

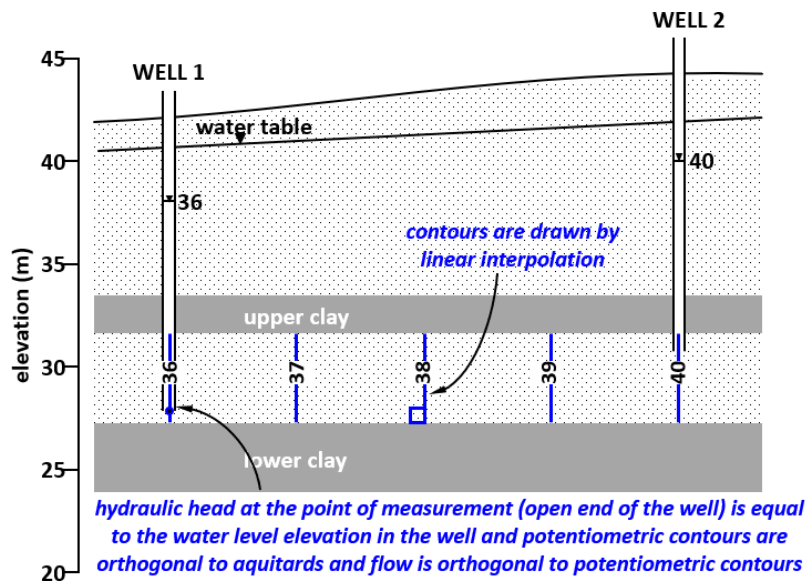

Solution 11b)

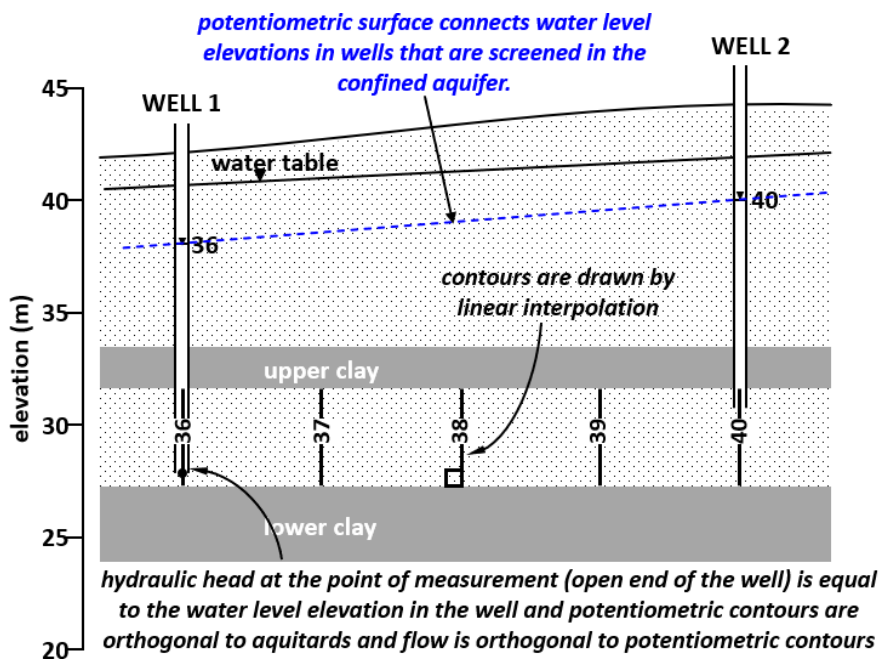

Solution 11c)

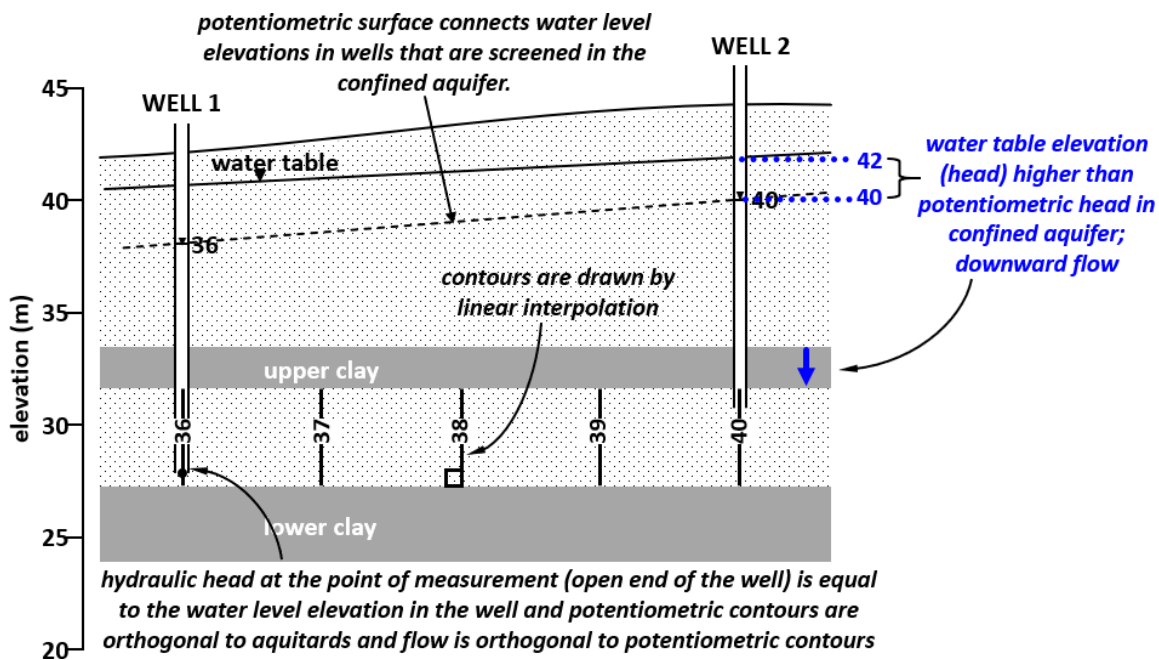

Solution 11d)

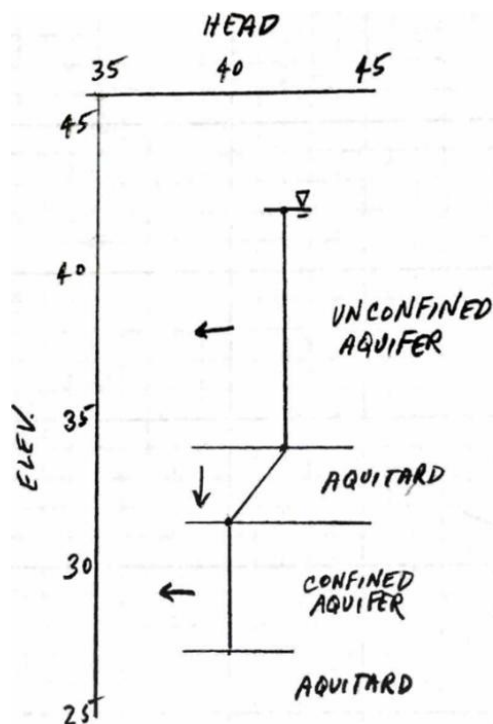

[Return to Example Problem 11](#) ↗

Problem 12 Solution

Instructions/questions:

- Draw potentiometric contours in the lower sand unit at 1 m intervals.
- Draw the potentiometric surface of the lower sand unit.
- What is the direction of groundwater flow through the upper clay unit? and
- Sketch the expected vertical head profile in the vicinity of Well 2.

Solution 12a)

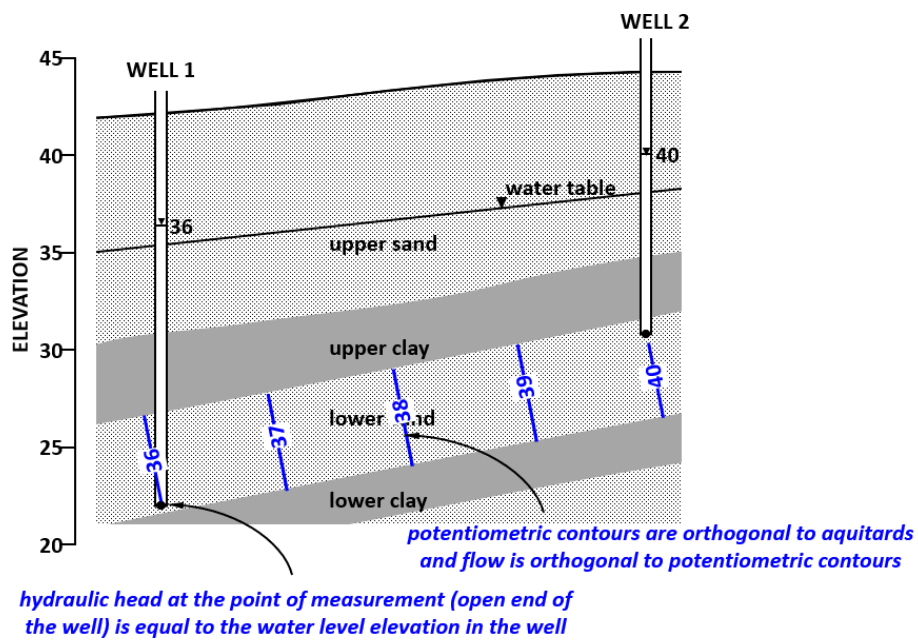

Solution 12b)

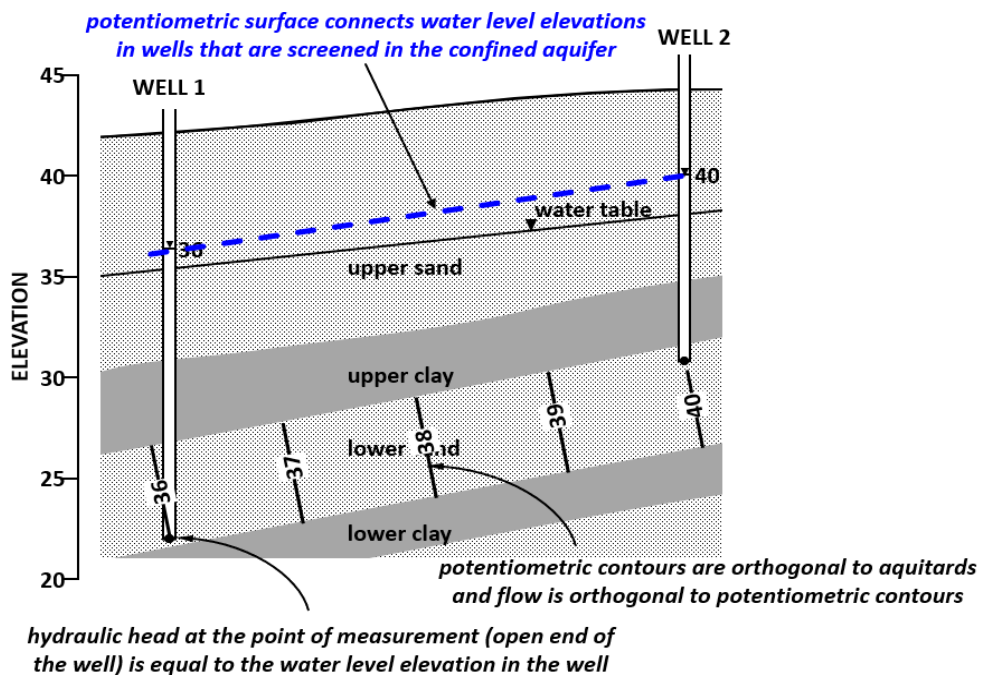

Solution 12c)

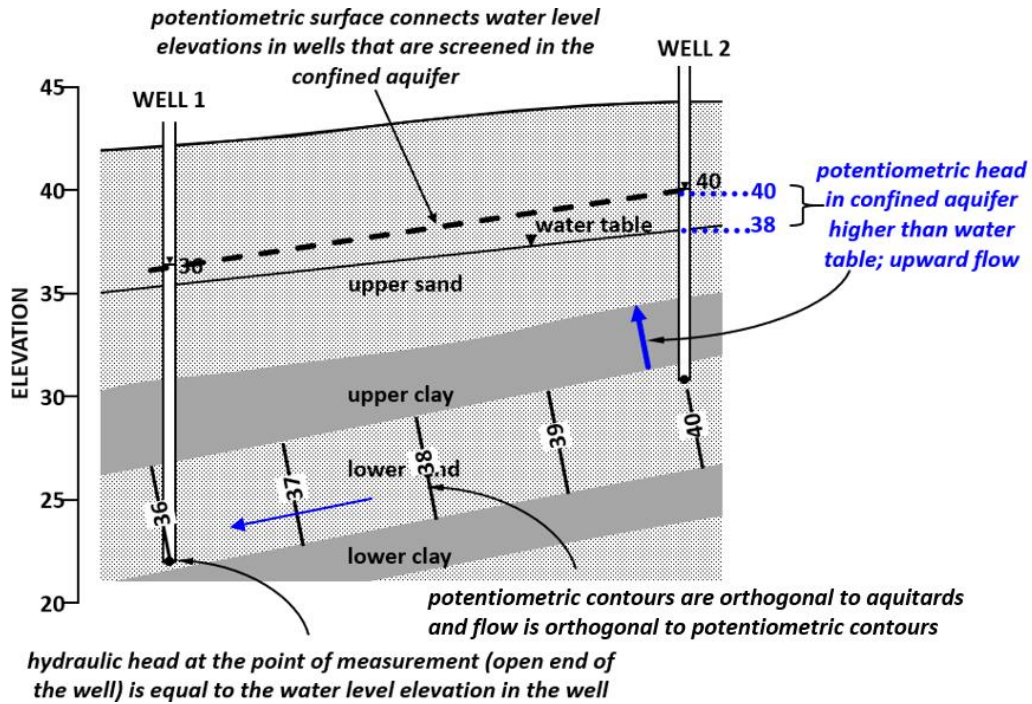

Solution 12d)

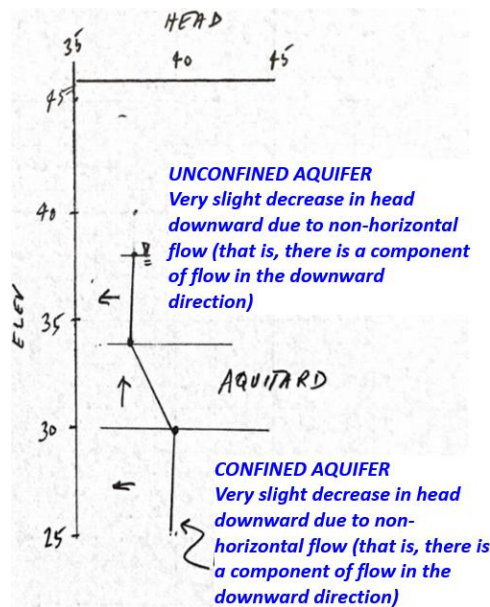

[Return to Example Problem 12](#) ↗

8 References

- Darcy, H. (1856). *Les fontaines publiques de la ville de Dijon* [The public fountains of the city of Dijon]. Dalmont.
- Woessner, W.W. & Poeter, E.P. (2020). *Hydrogeologic Properties of Earth Materials and Principles of Groundwater Flow*. The Groundwater Project. <https://doi.org/10.21083/978-1-7770541-2-0>.
- Poeter, E., & Hsieh, P. (2020). *Graphical Construction of Groundwater Flow Nets*. The Groundwater Project. <https://doi.org/10.21083/978-1-7770541-3-7>.

9 About the Authors



Dr. Andrew Cohen received his Ph.D. in Civil and Environmental Engineering from the University of California at Berkeley and a B.S. in Water Resources from the Department of Earth Sciences, State University of New York at Oneonta. His focus is hydrogeologic characterization of contaminated sites and related modeling of transport and fate of contaminants in soil, groundwater, surface water, and sediment. Prior to his current role as a contaminant hydrogeologist in the environmental consulting industry, he was a Research Associate at Lawrence Berkeley National Laboratory, where he focused on characterization and modeling of groundwater in fractured and faulted bedrock. He is Adjunct Professor at the New Jersey Institute of Technology, where he teaches Contaminant Hydrogeology.

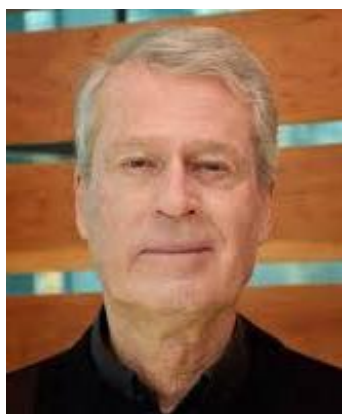

Dr. John Cherry, after study in the USA and a post-doc in France, joined the University of Waterloo in 1971 for field research on the migration and fate of contaminants in groundwater and their remediation. He co-authored "Groundwater" with R.A. Freeze (1979) and co-edited/co-authored several chapters in the book "Dense Chlorinated Solvents....in Groundwater" (1996). He is the founding Director of the University Consortium for Field-Focused Groundwater Contamination Research. At the G360 Centre for Groundwater Research, University of Guelph, he participates in research on groundwater monitoring technologies and creating safe wells for rural people in remote terrain. He was Chair of the Canadian Expert Panel on Environmental Impacts of Shale Gas development (2012-2014). He is a Foreign Member of the U.S. Academy of Engineering. He received the Lee Kwan Yew Water Prize in 2016, and the Stockholm Water Prize, 2020.

Please consider signing up for the GW-Project mailing list to stay informed about new book releases, events and ways to participate in the GW-Project. When you sign up for our email list it helps us build a global groundwater community. [Sign up](#)[↗].

